



**AUFBAUANLEITUNG  
SCHIEBETÜR 4M**

# Schiebetür 4m

sliding door 4m



# SCT00 - System Übersicht

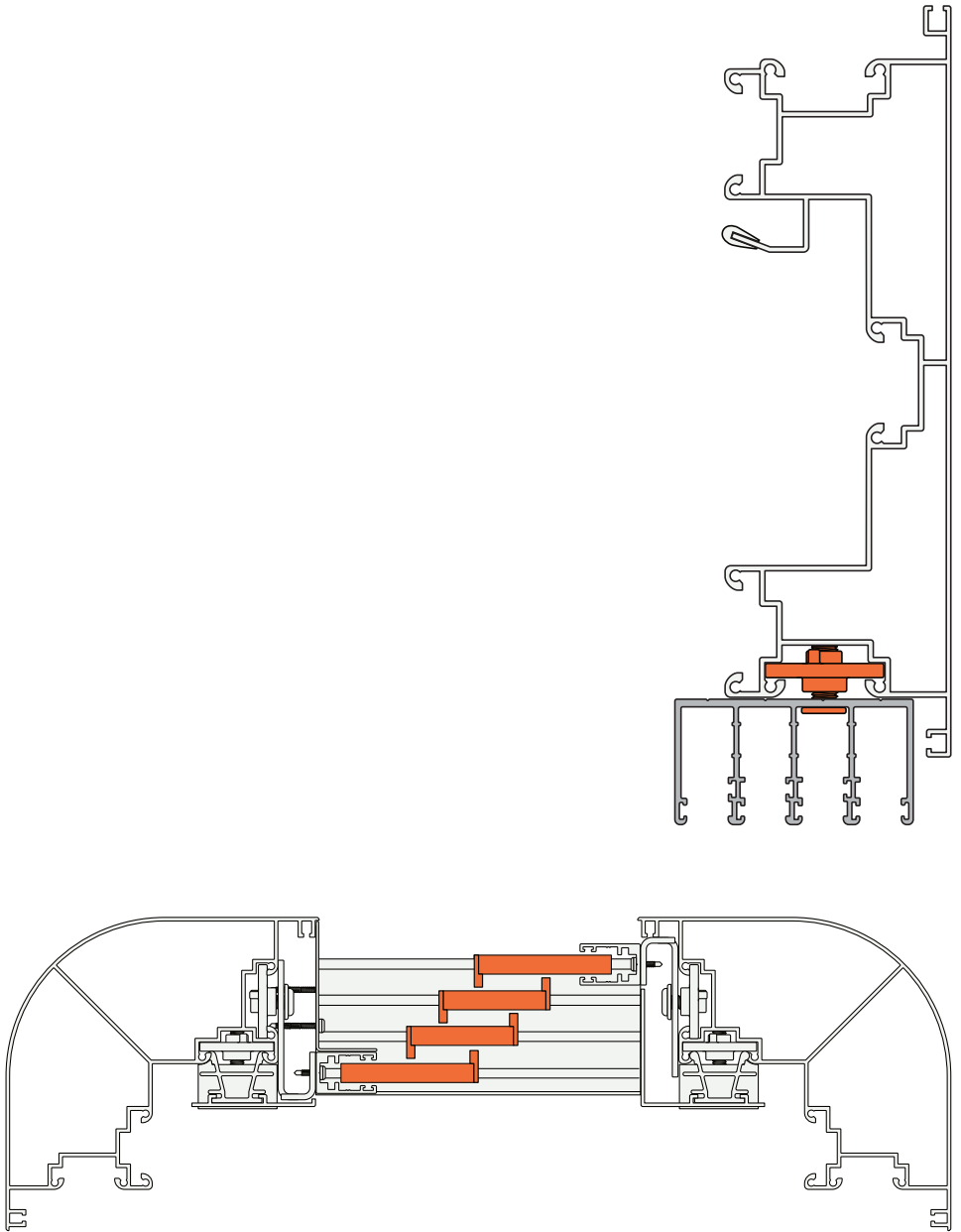

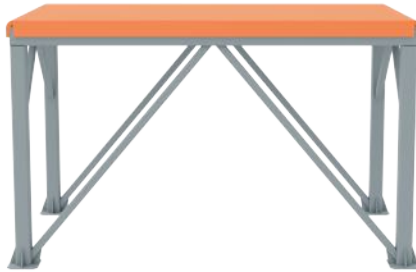

**Die Arbeitsfläche (Böcke, Werkbank...) für die Auflage der Glasscheiben polstern.**





**Kratzer am Glas müssen vermieden werden!**



Pad the work surface (trestles, workbench, etc.) where the glass panes are placed.

Scratches on the glass must be avoided!

## SCT02 - Montage Anschlagleisten

|                                                                                                                   |                                                                                                                                           |
|-------------------------------------------------------------------------------------------------------------------|-------------------------------------------------------------------------------------------------------------------------------------------|
|  <p>Anschlagleiste</p> <p>2x</p> |  <p>Nutstein</p> <p>10x</p>                              |
|  <p>Füllblock</p> <p>2x</p>      |  <p>Breitflanschschraube<br/><b>M8x16</b></p> <p>10x</p> |

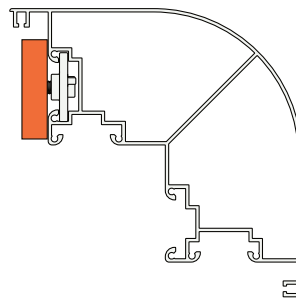
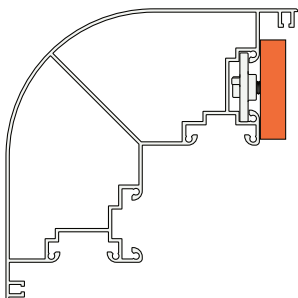

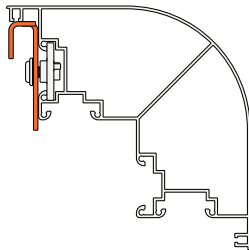
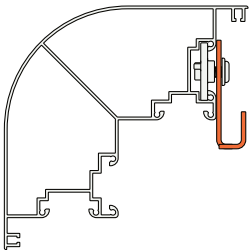
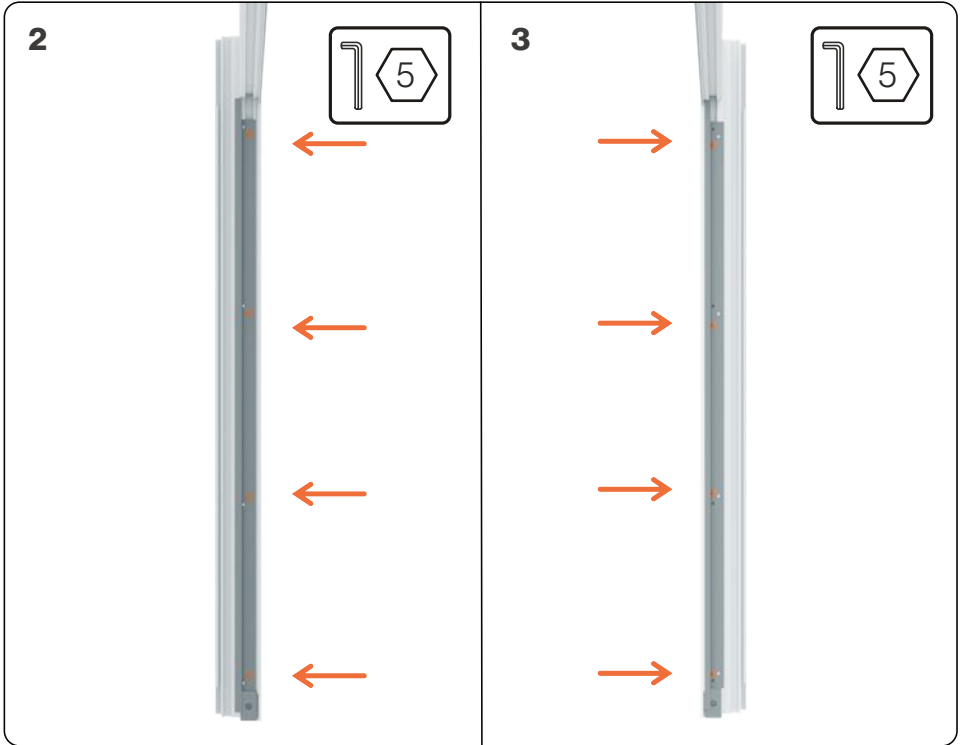
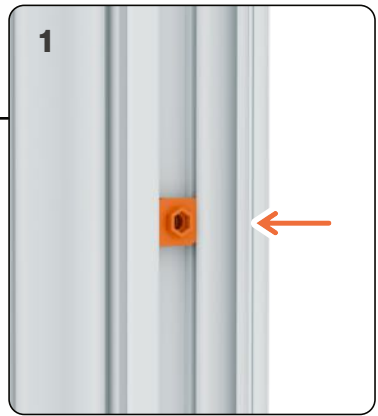

# SCT03 - Befestigungslöcher Deckenschiene bohren

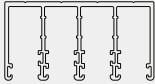

Deckenschiene  
4-gleisig

1x

150mm -500mm -500mm -500mm -500mm -500mm -500mm -500mm 150mm



|                |                                                                 |
|----------------|-----------------------------------------------------------------|
| <p>1 2 3 4</p> | <p>Ø4</p>                                                       |
| <p>8,5-9</p>   | <p>! Alle Löcher entgraten.<br/>Deburr all holes.</p> <p>8x</p> |

# SCT04 - Montage Deckenschiene



Nutstein

8x

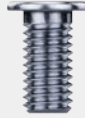

Schraube  
**M8x16**

8x

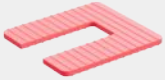

Distanzplättchen

3x

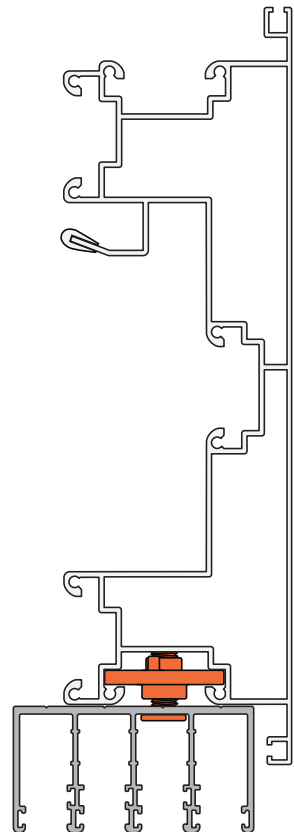
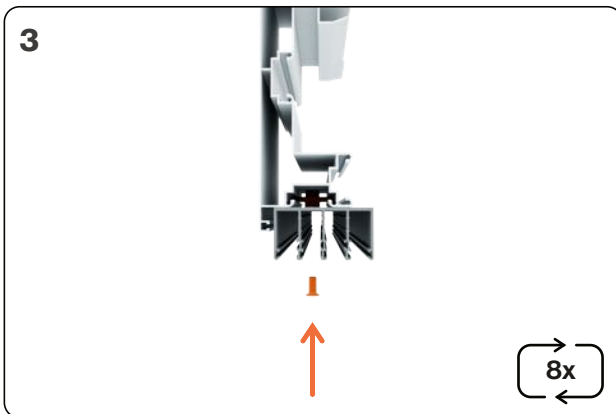
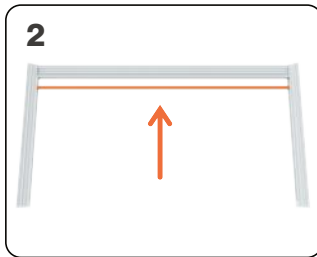
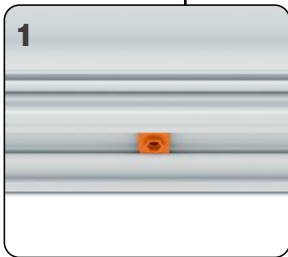
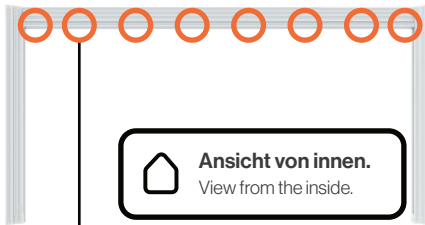

1

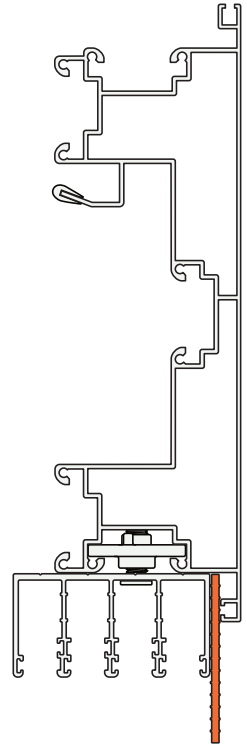
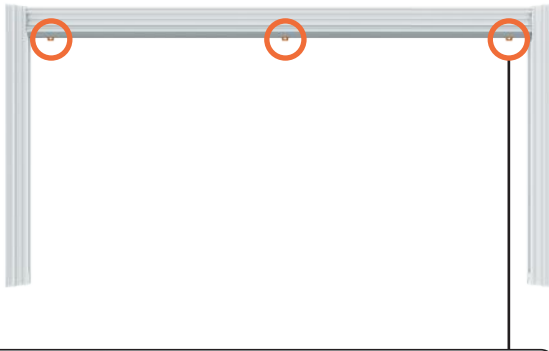

2

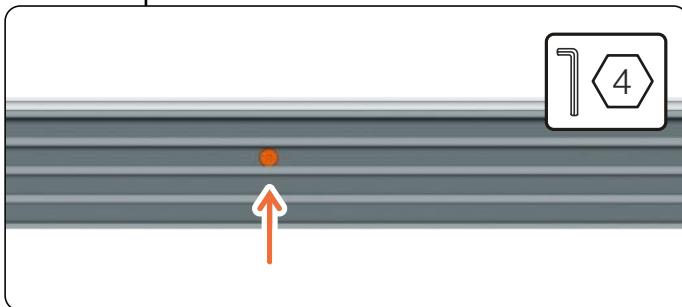
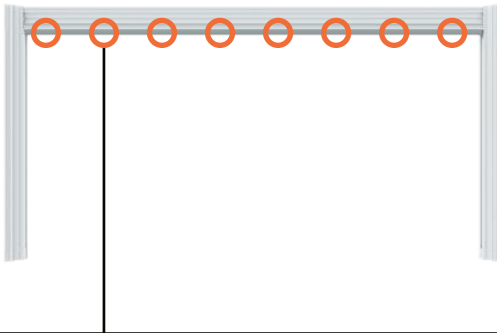

## SCT05 - Vorbereitung Bodenprofil

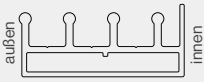

Bodenprofil 4m

1x



Abdeckung  
Bodenschiene

1xL 1xR

100mm -700mm -700mm -700mm -700mm -700mm -700mm 100mm

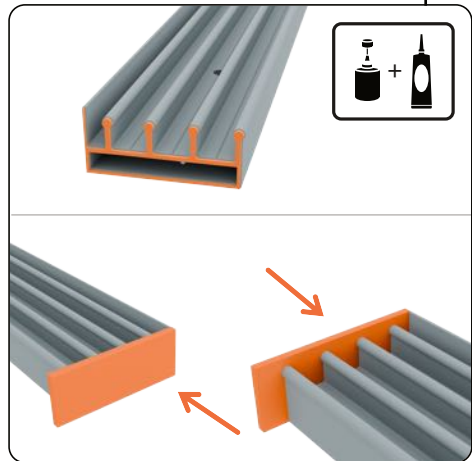
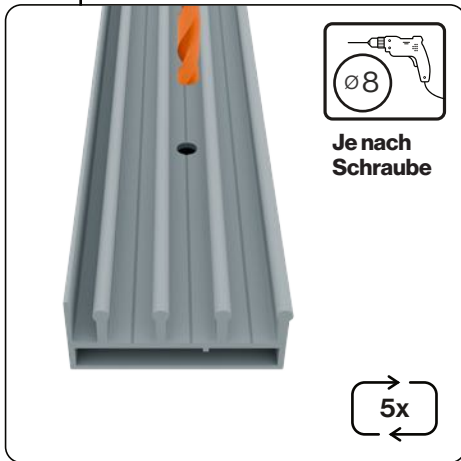
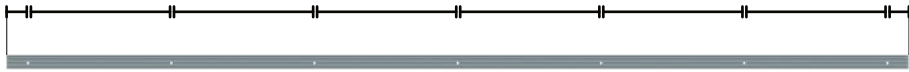

**Bodenschiene noch nicht festschrauben.**

**Die Löcher im Untergrund erst nach Fertigstellung der gesamten Anlage bohren.**

Do not screw down the bottom track yet.



Drill the holes in the ground only after the entire structure is completed.

# SCT06 - Vorbereitung Glaseinfassungsprofil

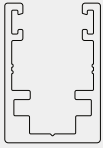

Glaseinfassungsprofil

1x

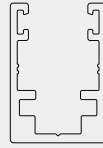

Glaseinfassungsprofil  
MIT FRÄSUNG

1x

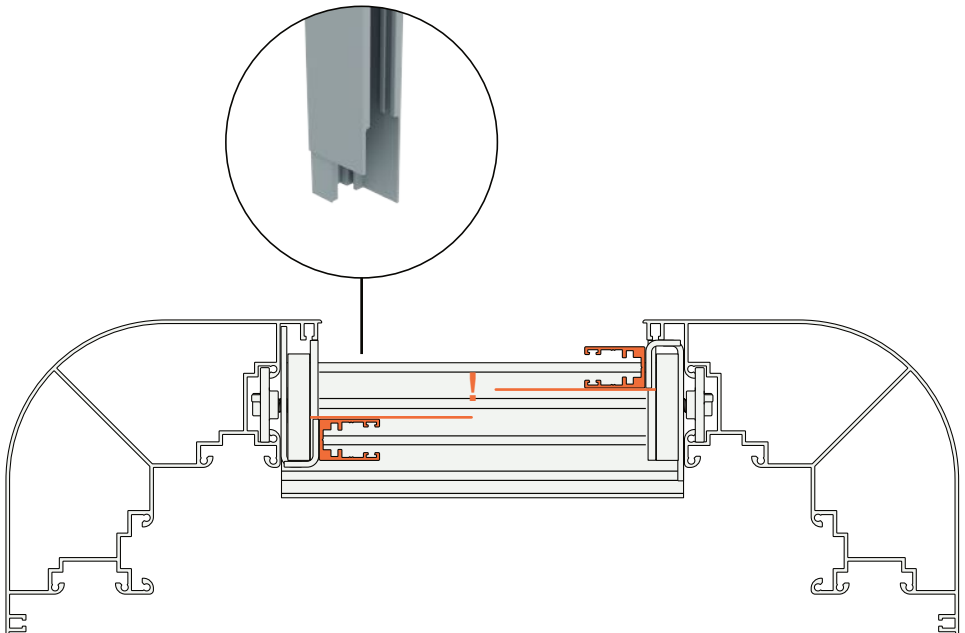
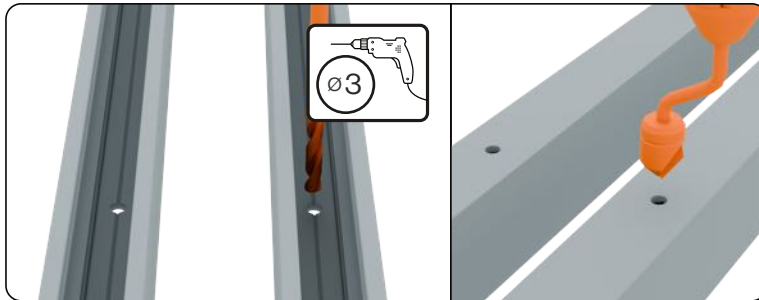
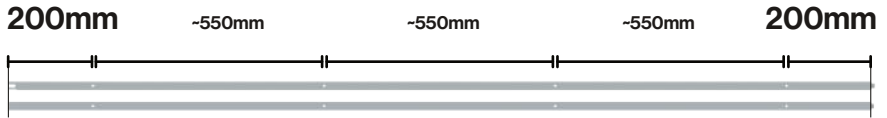

1



 **Ansicht von innen.**  
View from the inside.

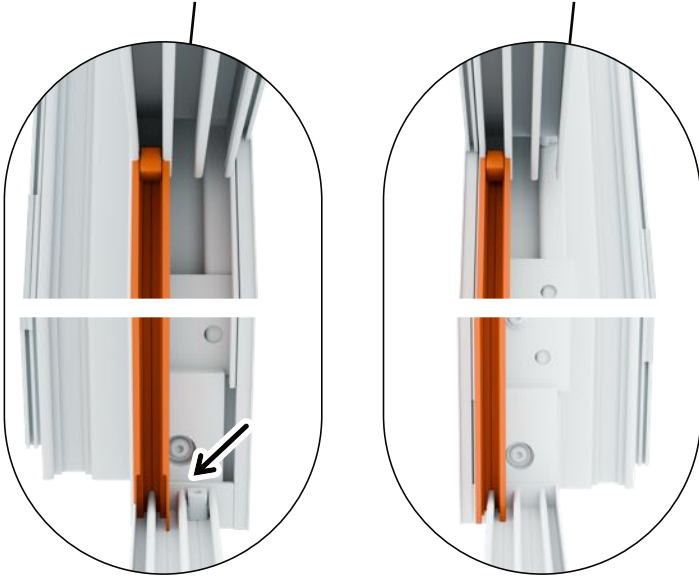

2

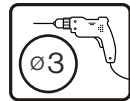
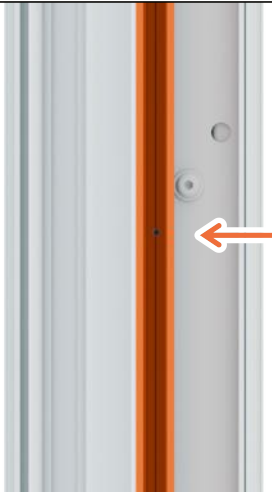

## SCT07 - Montage Glaseinfassungsprofil



Schraube  
**3,9x13**

8x

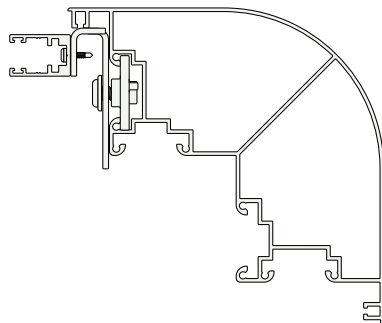
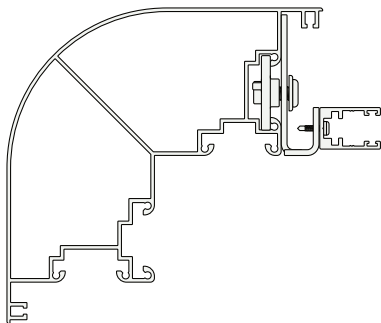

## SCT08 - Glas vorbereiten

|                                                                                   |                                                                              |                                                                                                                                    |
|-----------------------------------------------------------------------------------|------------------------------------------------------------------------------|------------------------------------------------------------------------------------------------------------------------------------|
|  | <p><b>Laufschiene mit/ohne Verriegelungsmechanik</b></p> <p><b>2x/2x</b></p> |  <p><b>Fixierungsleiste</b></p> <p><b>4x</b></p>  |
|   | <p><b>Distanzplättchen 3mm wiederverwenden</b></p>                           |  <p><b>Wurmschraube M5x5</b></p> <p><b>8x</b></p> |

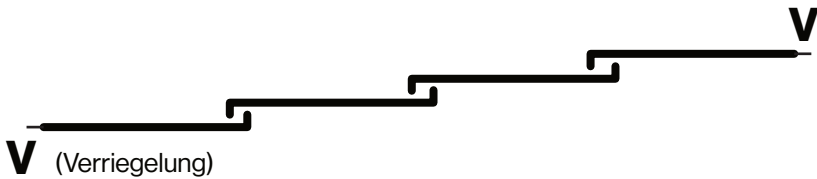
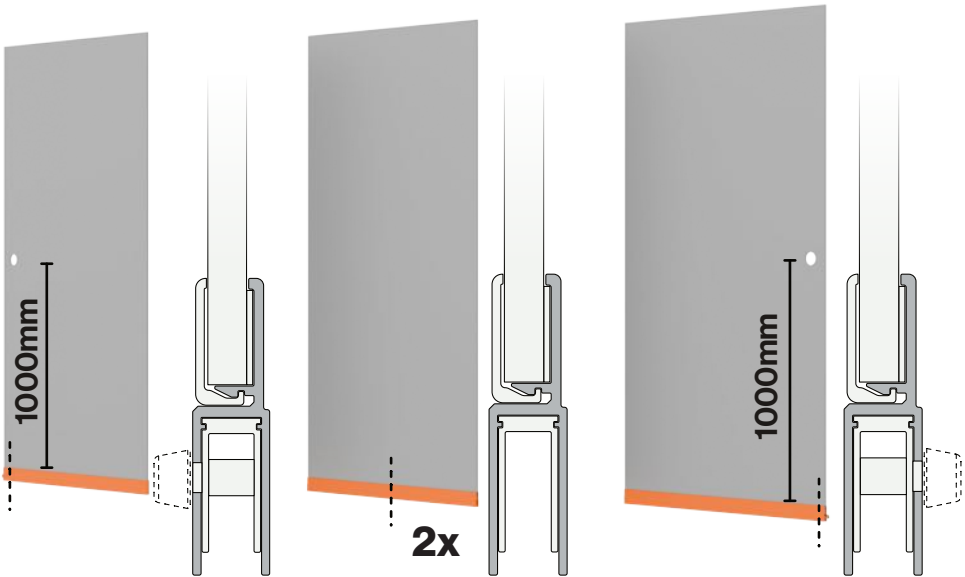

**Grifflöcher ganz links und ganz rechts, Fixierungsleiste immer innen oder außen, Verriegelung links außen und rechts innen.**

Grip holes on the far left and far right, fixing strip always on the inside or outside, locking mechanism on the left outside and right inside.



I  
>50mm

- ! **Außenseite nach unten (Sticker am Glas).**  
**Klebbereich reinigen und abtrocknen lassen.**
- Outside facing down (sticker on glass).
- Clean the bonding area and let it dry.

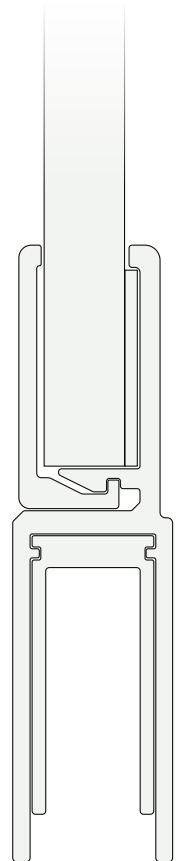
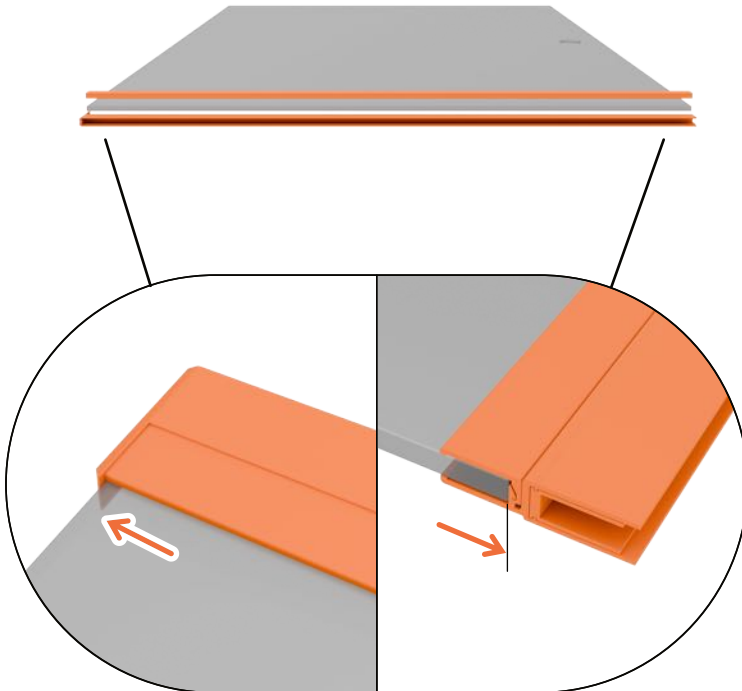

1



2

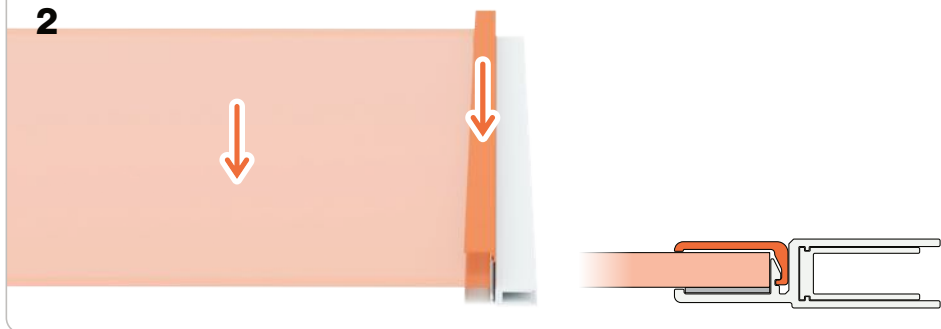

3

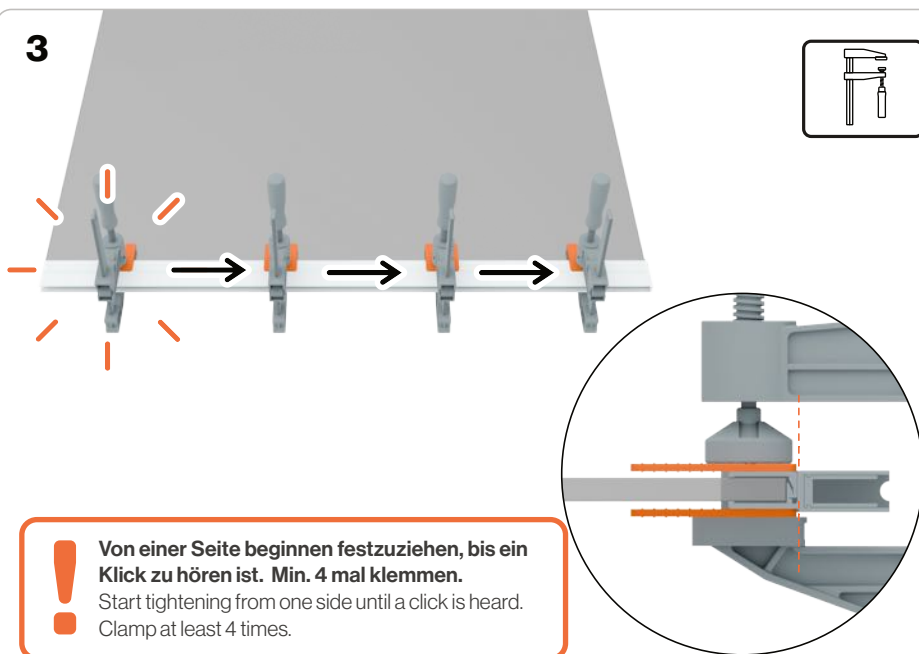

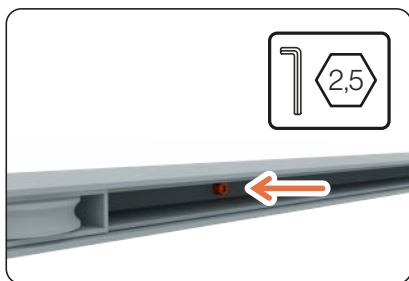
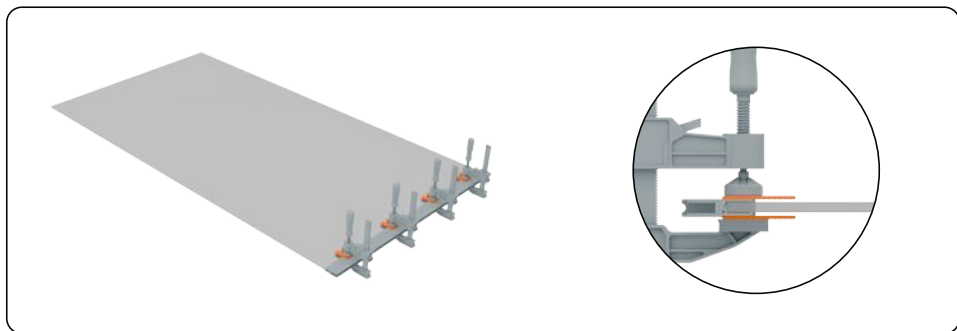
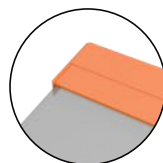
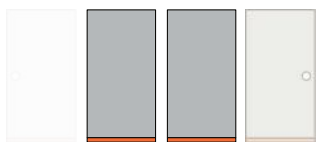
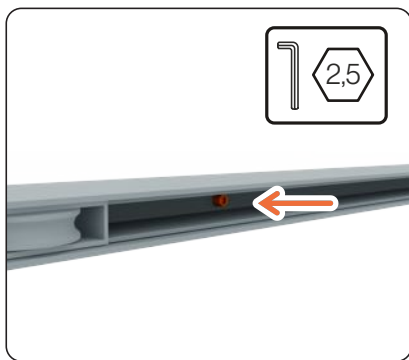

## SCT09 - Montage Abdeckwinkel



Abdeckwinkel

1x

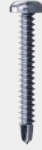

Linsenkopf-Bohrschraube

3,9x25

4x

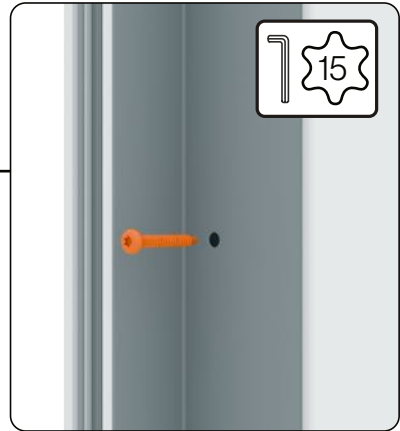

**Schrauben nicht zu fest ziehen.**

Do not tighten to much.

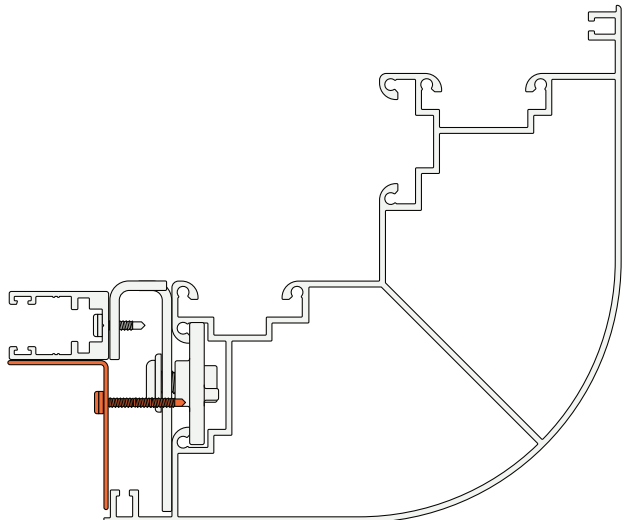

# SCT10 - Schiebeelemente einhängen



Schiebetürelemente

4x

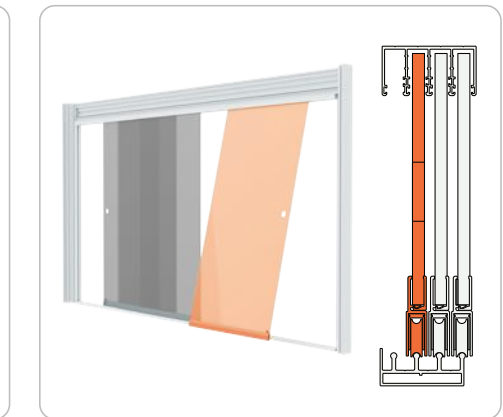
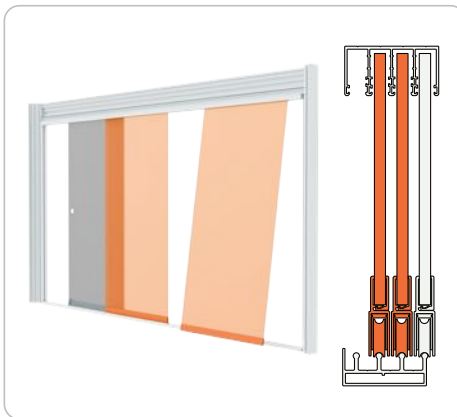
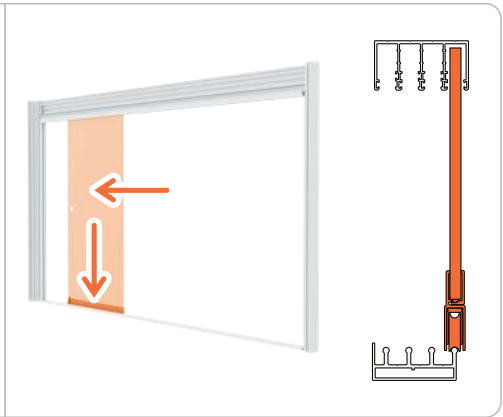
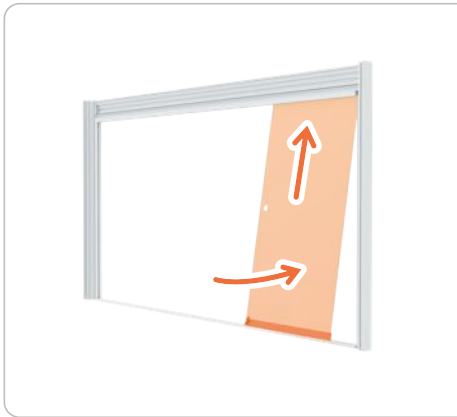
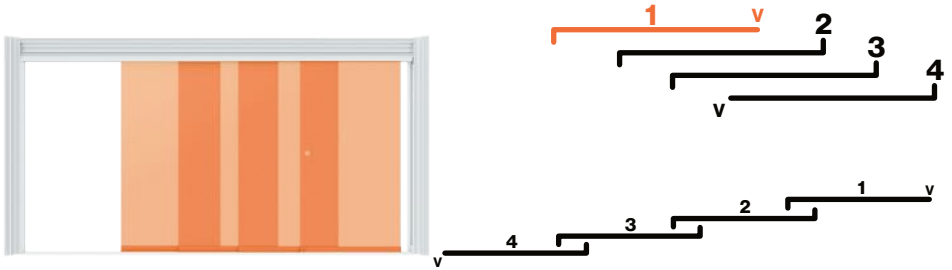

## SCT11 - Einfassungen ausrichten

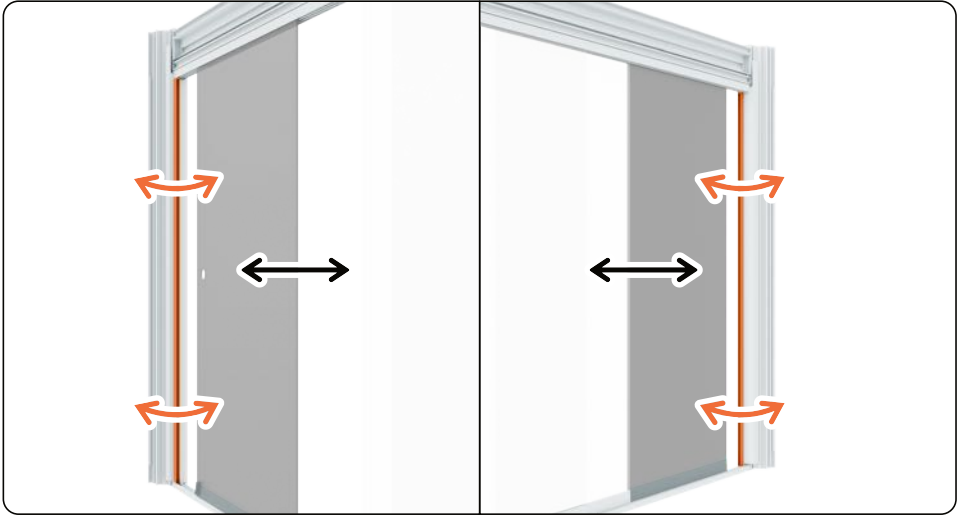

**!** Ecksteher/Seitenwände gemäß der Glaselemente ausrichten;  
Glaseinfassungsleiste muss parallel zum Glas sein - Glas muss in die Glaseinfassungsleiste einfahren können.

• Align corner posts/side walls according to the glass elements; the glazing bead must be parallel to the glass - the glass must be able to slide into the glazing bead.

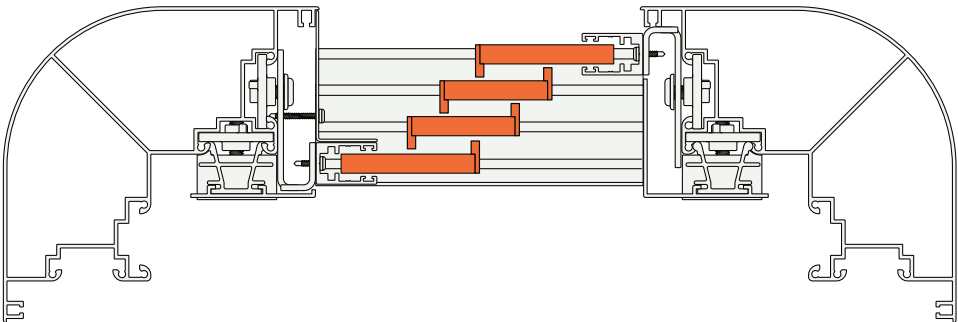

## SCT12 - Vorbereitung Schiebeelemente



Laufschiene  
mit Verriegelungsmechanik

1x



Verriegelungshebel

1x

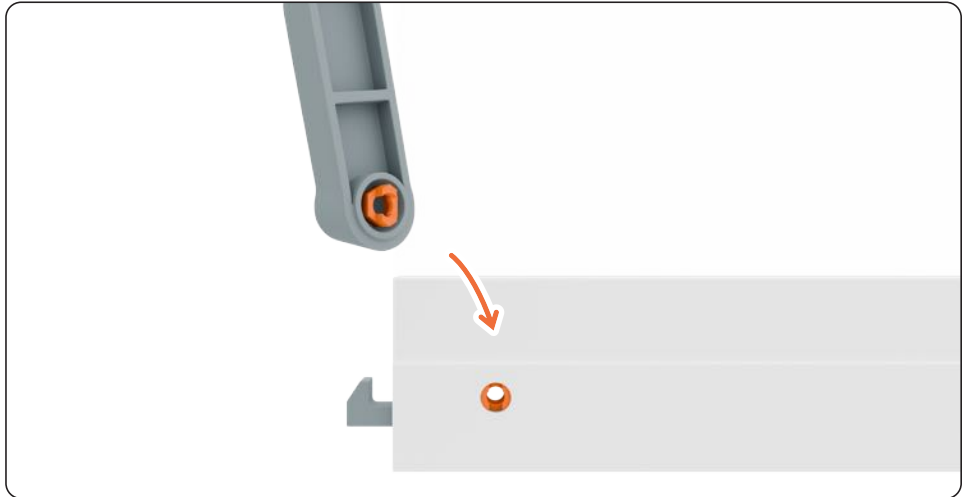

## ■ SCT13 - Verriegelung einstellen

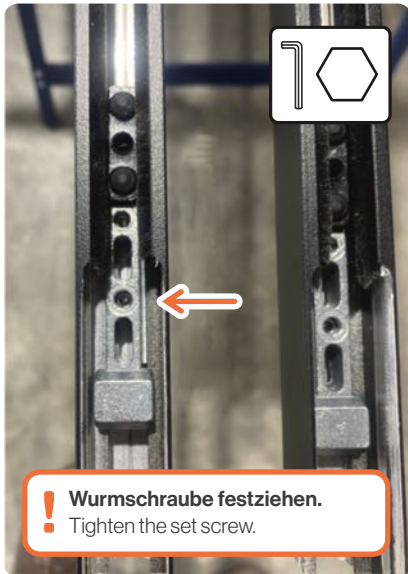
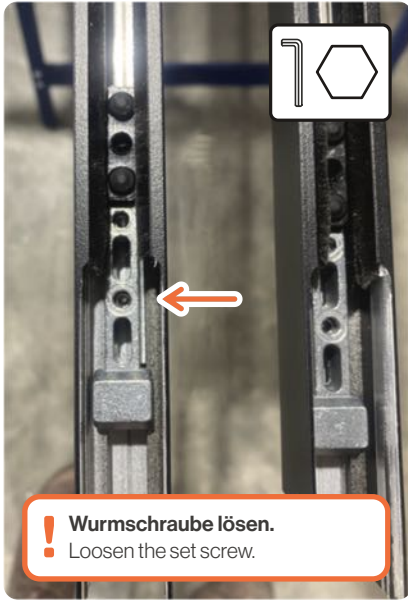

## SCT14 - Bodenschiene befestigen

Schrauben je nach Untergrund

7x

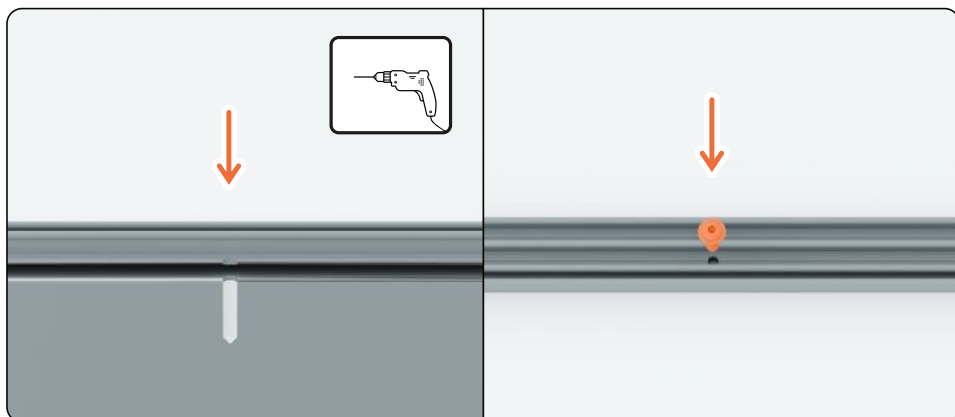

**Entsprechend dem gewählten Fundament muss die Bodenschiene sicher verschraubt werden.**



Depending on the selected foundation, the floor rail must be securely bolted.

## SCT15 - Aushängesicherung einstellen

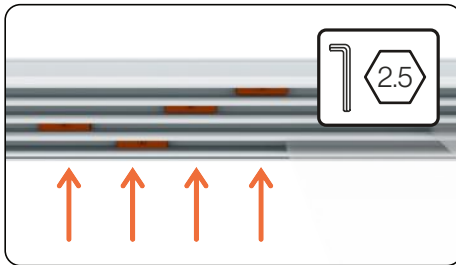
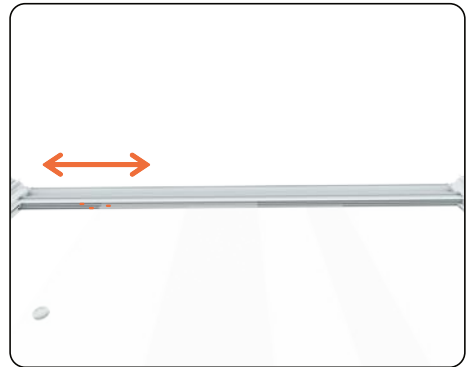
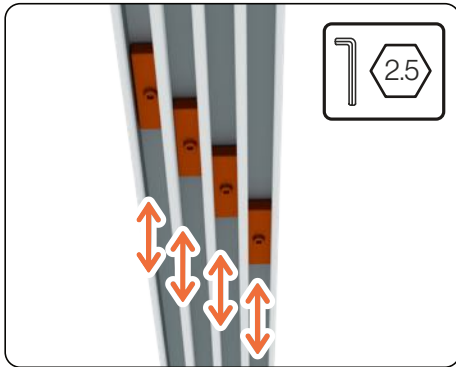
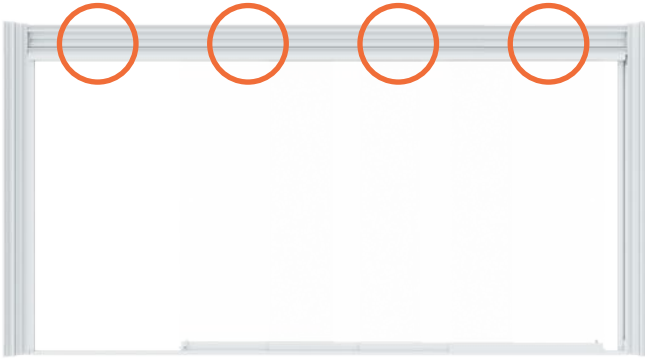

**!** Die Aushängesicherungen jeweils in die Mitte der Scheiben platzieren.  
Place the safety retainers in the center of each glass panel.

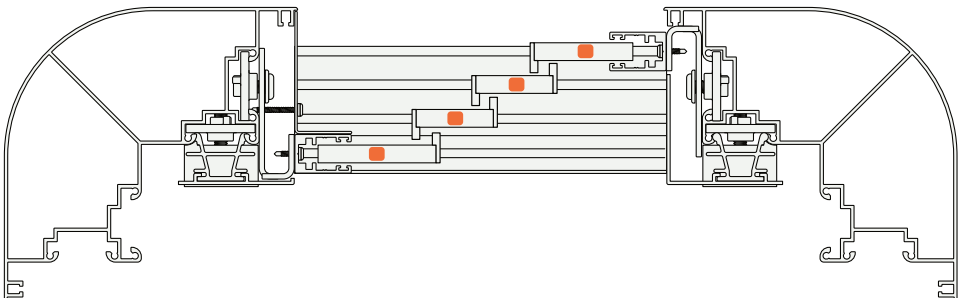

## SCT16 - Griffmuscheln montieren



Griffmuschel

2x

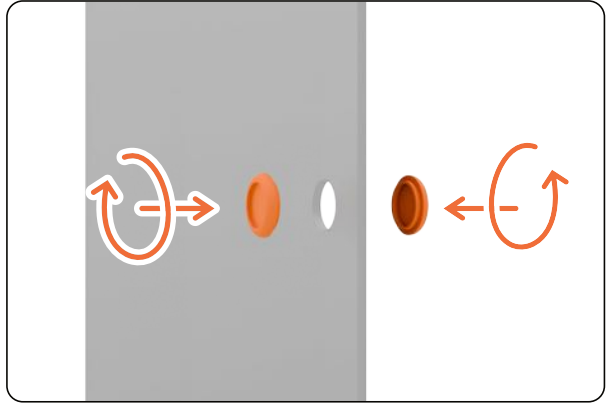

## SCT17 - Bürstenleisten montieren

Bürstenleiste

2x

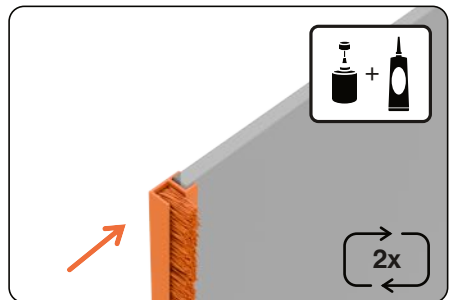

## SCT18 - Montage Innenabdeckungsstopper



Innenabdeckungs-  
stopper

2x

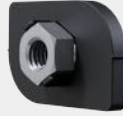

Nutstein

2x

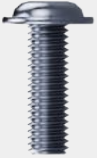

Schraube  
**M8x25**

2x

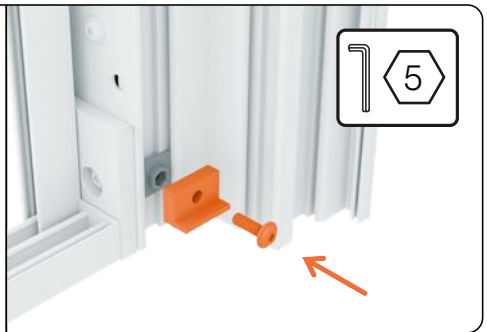
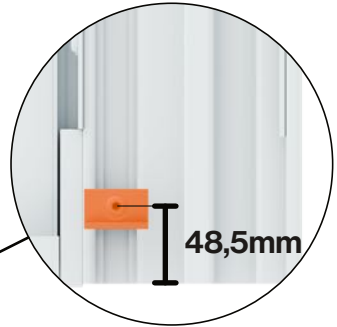

# SCT19 - Montage Innenabdeckung

|                                                                                   |                        |                                                                                   |                        |
|-----------------------------------------------------------------------------------|------------------------|-----------------------------------------------------------------------------------|------------------------|
|  | Innenabdeckung L<br>1x |  | Innenabdeckung R<br>1x |
|  | Abdeckklipp hoch<br>8x |                                                                                   |                        |

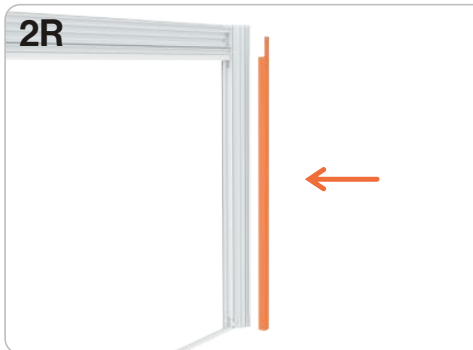
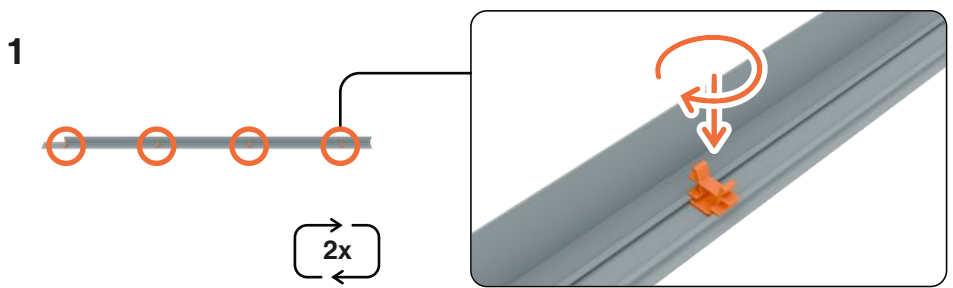
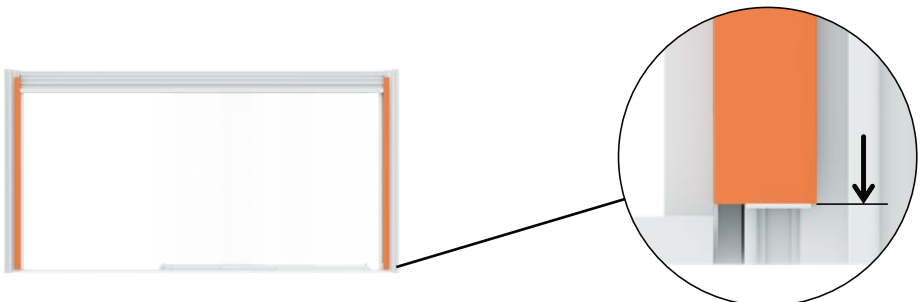



**SUNELEMENTS GMBH**

Sportstraße 7  
4142 Hofkirchen i. M.  
Austria

[www.sunelements.at](http://www.sunelements.at)  
[office@sunelements.at](mailto:office@sunelements.at)

+43 7285 93 08 00