



**AUFBAUANLEITUNG
SCHIEBETÜR 3M**

Schiebetür 3m

sliding door 3m



SCT00 - System Übersicht

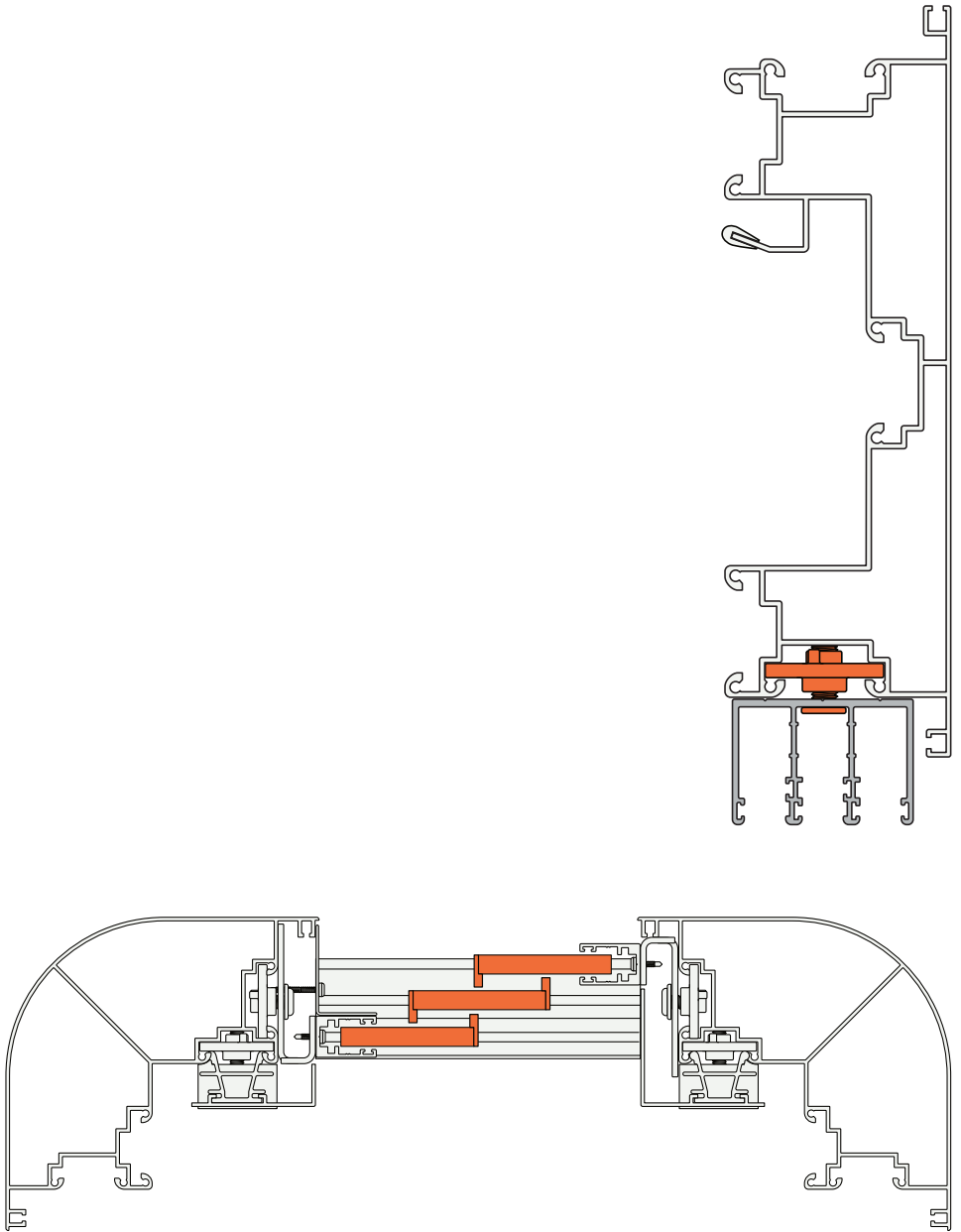

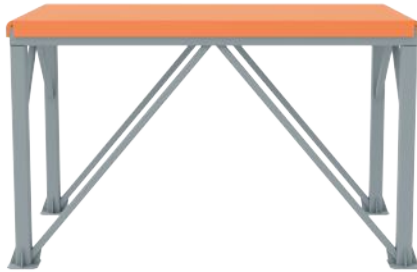

Die Arbeitsfläche (Böcke, Werkbank...) für die Auflage der Glasscheiben polstern.





Kratzer am Glas müssen vermieden werden!



Pad the work surface (trestles, workbench, etc.) where the glass panes are placed.

Scratches on the glass must be avoided!

SCT02 - Montage Anschlagleisten

 <p>Anschlagleiste</p> <p>2x</p>	 <p>Nutstein</p> <p>10x</p>
 <p>Füllblock</p> <p>2x</p>	 <p>Breitflanschschraube M8x16</p> <p>10x</p>



 **Ansicht von innen.**
View from the inside.

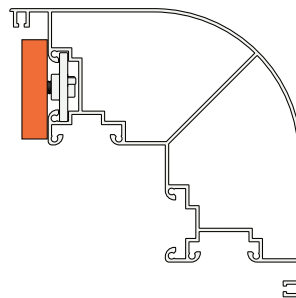
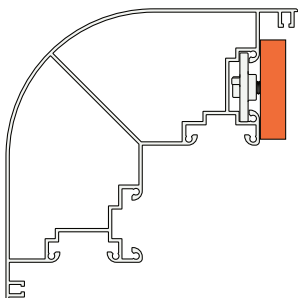

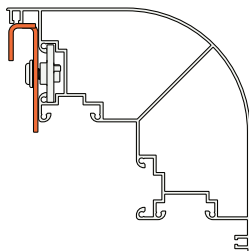
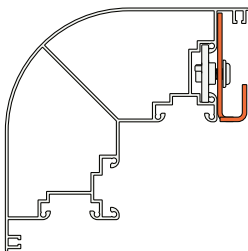
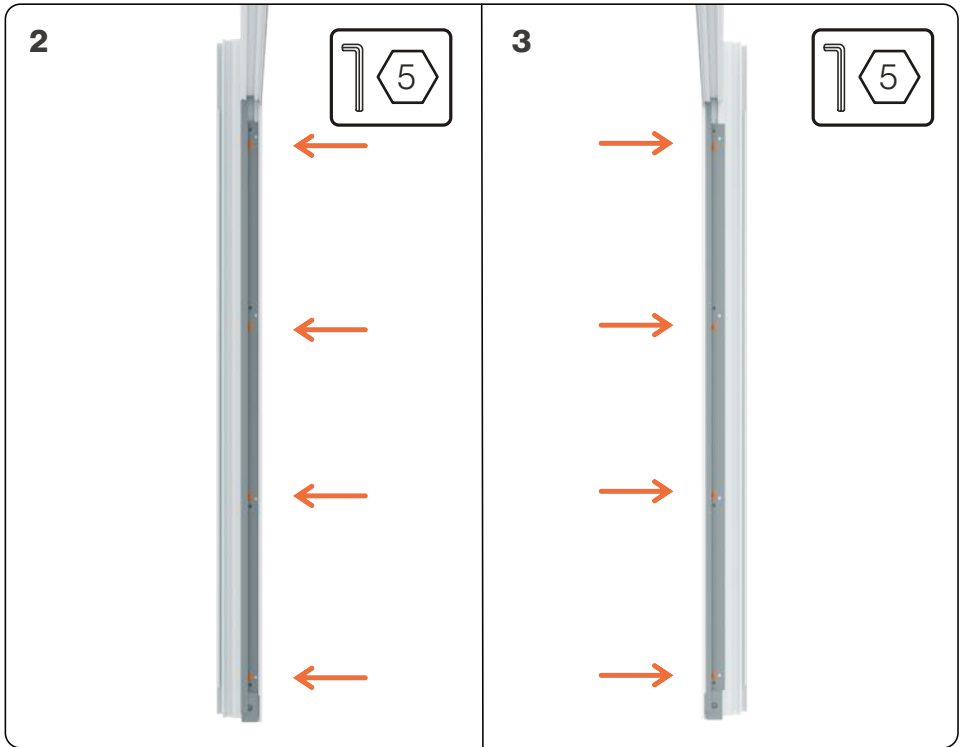
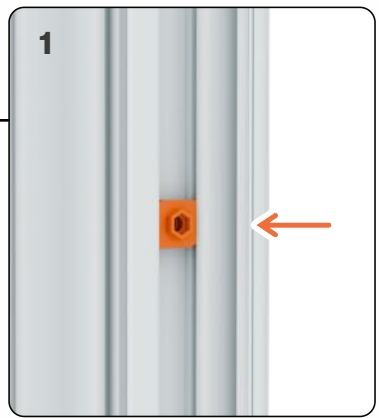

SCT03 - Befestigungslöcher Deckenschiene bohren

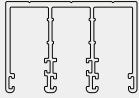

Deckenschiene
3-gleisig

1x

150mm ~700mm ~700mm ~700mm ~700mm 150mm

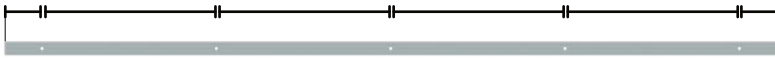

<p>1 2 3</p>	<p>Ø4</p>
<p>8,5-9</p>	<p>Alle Löcher entgraten. Deburr all holes.</p> <p>6x</p>

SCT04 - Montage Deckenschiene



Nutstein

6x

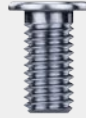

Schraube
M8x16

6x

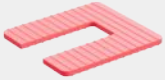

Distanzplättchen

3x

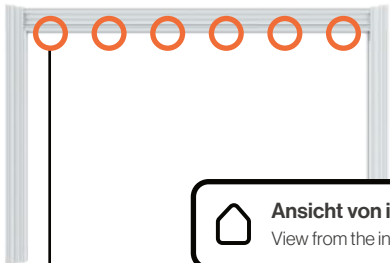

Ansicht von innen.
View from the inside.

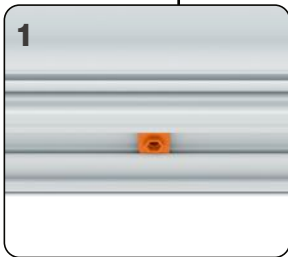

1

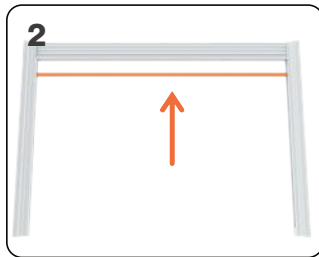

2

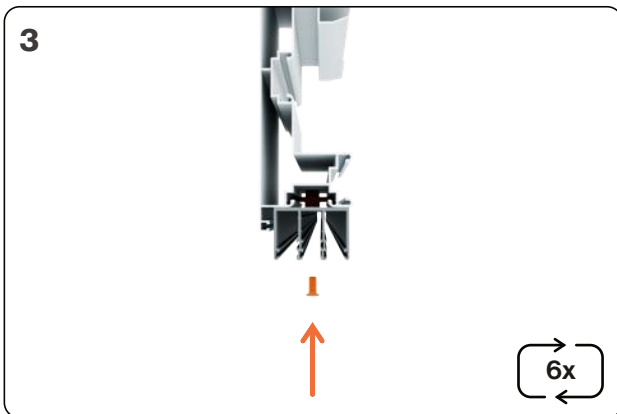

3

6x

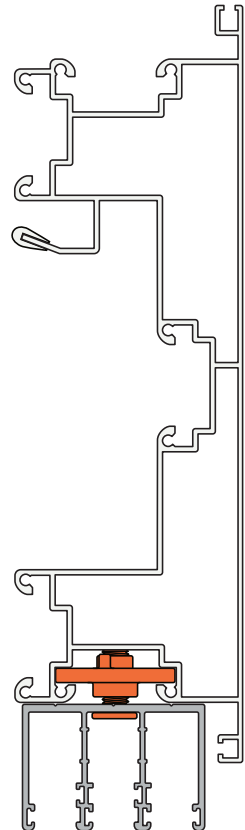

1

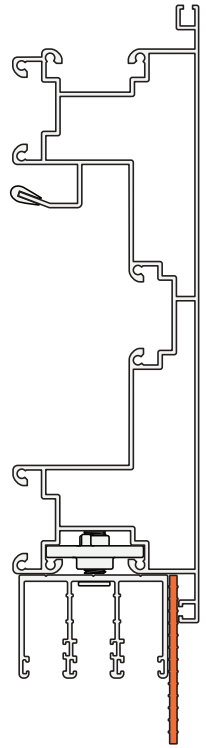
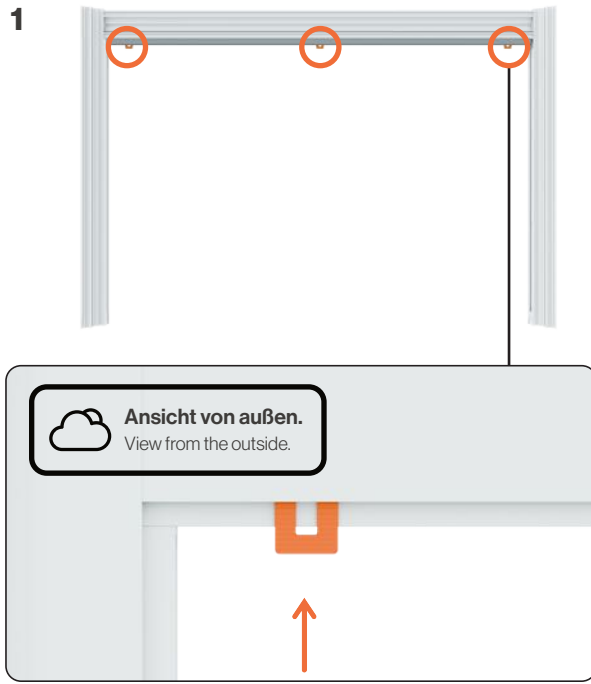

2

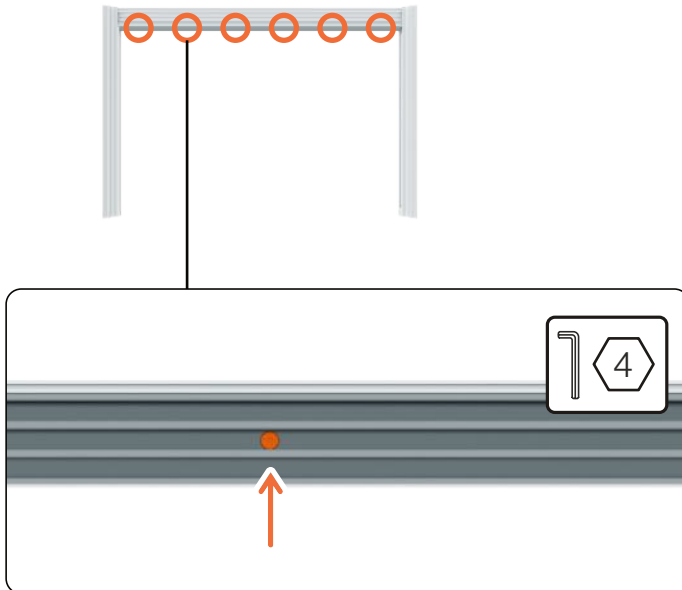

SCT05 - Vorbereitung Bodenprofil

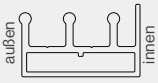

Bodenprofil

1x



Abdeckung
Bodenschiene

1xL 1xR

100mm -700mm -700mm -700mm -700mm 100mm

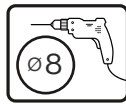

Je nach
Schraube

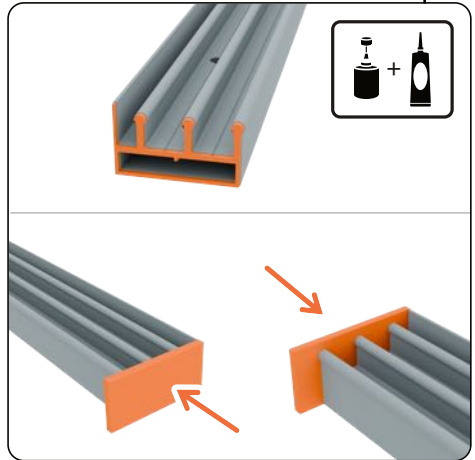

Bodenschiene noch nicht festschrauben.

Die Löcher im Untergrund erst nach Fertigstellung der gesamten Anlage bohren.

Do not screw down the bottom track yet.



Drill the holes in the ground only after the entire structure is completed.

SCT06 - Vorbereitung Glaseinfassungsprofil

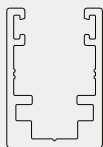

Glaseinfassungsprofil

1x

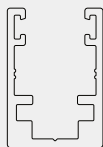

Glaseinfassungsprofil
MIT FRÄSUNG

1x

200mm ~550mm ~550mm ~550mm 200mm

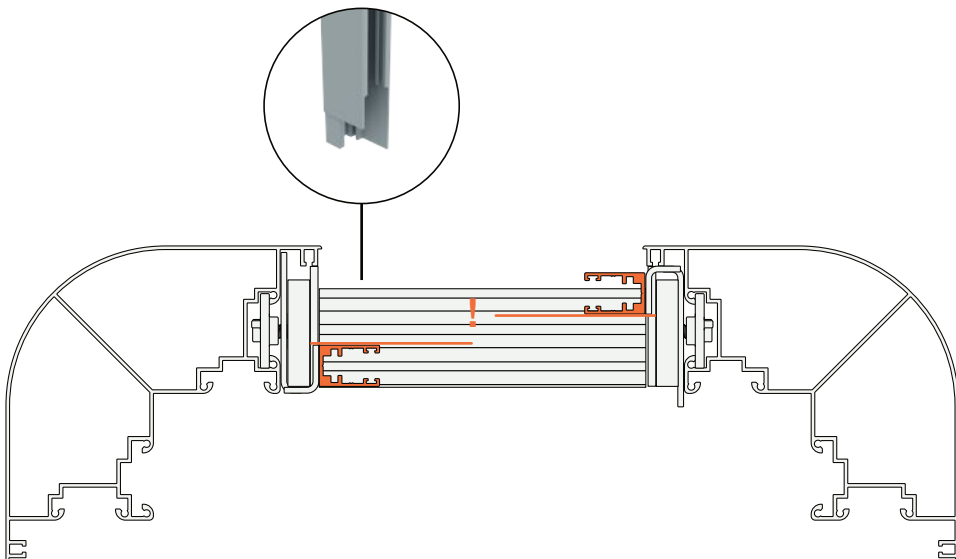
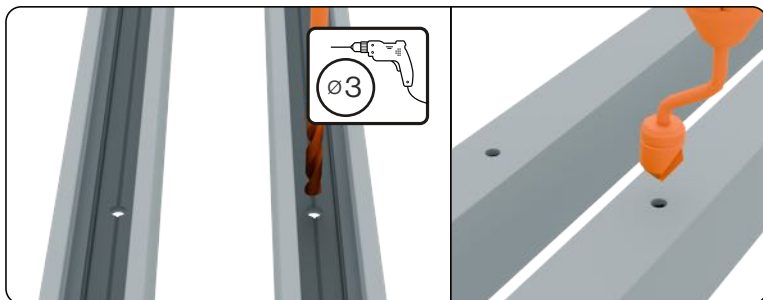

1



 **Ansicht von innen.**
View from the inside.

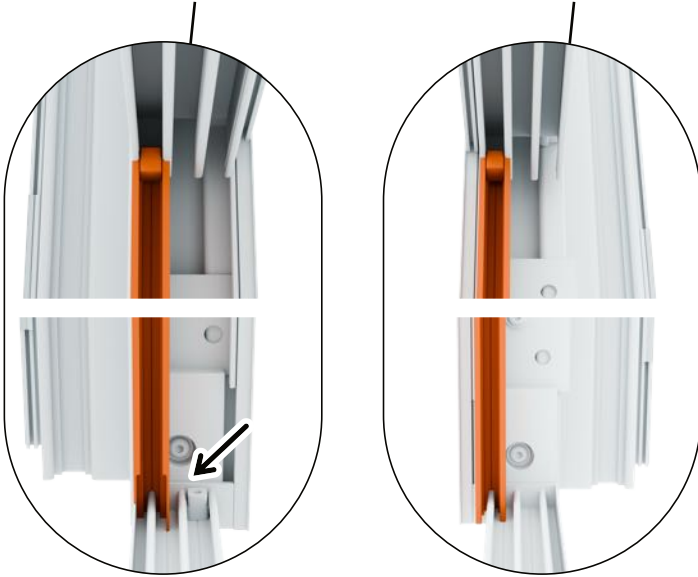

2

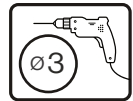
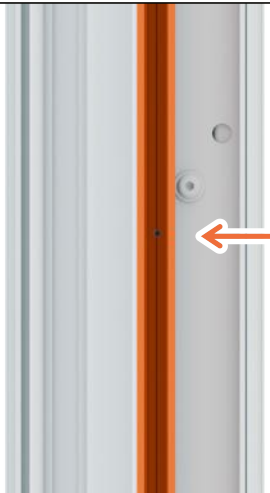

SCT07 - Montage Glaseinfassungsprofil



Schraube
3,9x13

8x

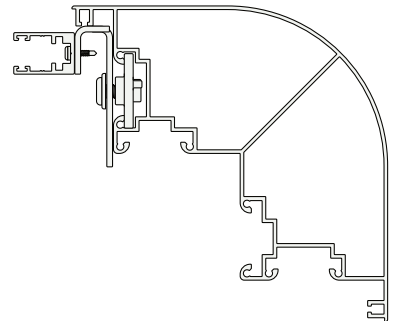
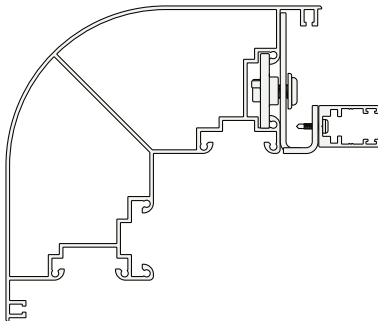
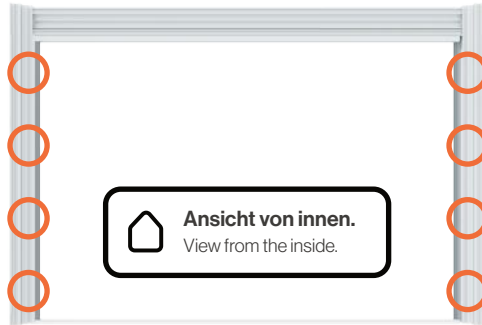

SCT08 - Glas vorbereiten

	<p>Laufschiene mit/ohne Verriegelungsmechanik</p> <p>2x/1x</p>		<p>Fixierungsleiste</p>
	<p>Distanzplättchen 3mm wiederverwenden</p> <p>8x</p>		<p>Wurmschraube M5x5</p> <p>6x</p>

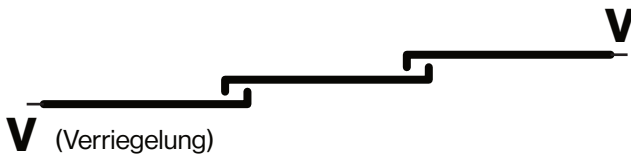
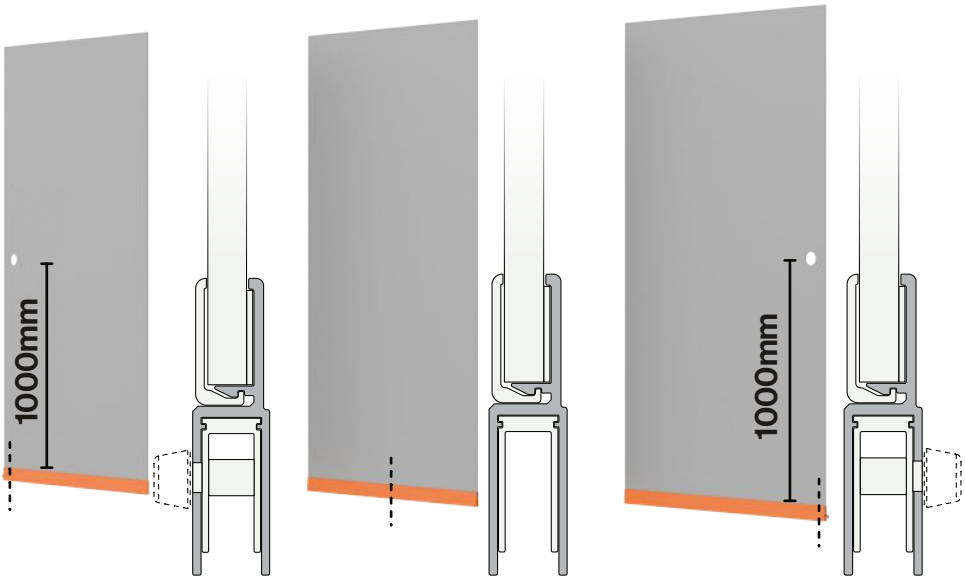

! **Grifflöcher ganz links und ganz rechts, Fixierungsleiste immer innen oder außen, Verriegelung links außen und rechts innen.**
 Grip holes on the far left and far right, fixing strip always on the inside or outside, locking mechanism on the left outside and right inside.



I
>50mm

**Außenseite nach unten (Sticker am Glas).
Klebbereich reinigen und abtrocknen lassen.**

- ! Outside facing down (sticker on glass).
- Clean the bonding area and let it dry.

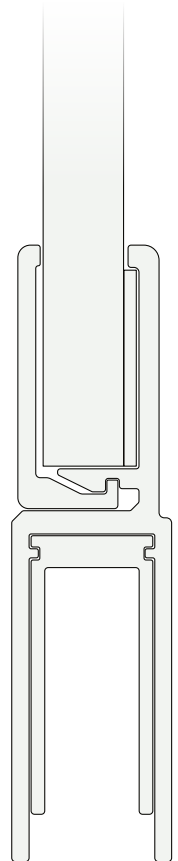
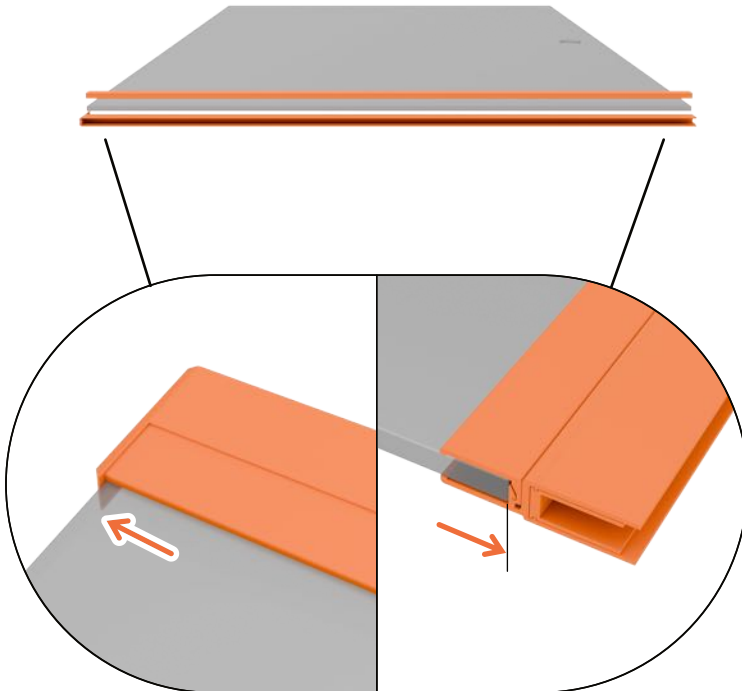
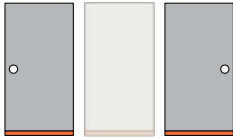

1



2

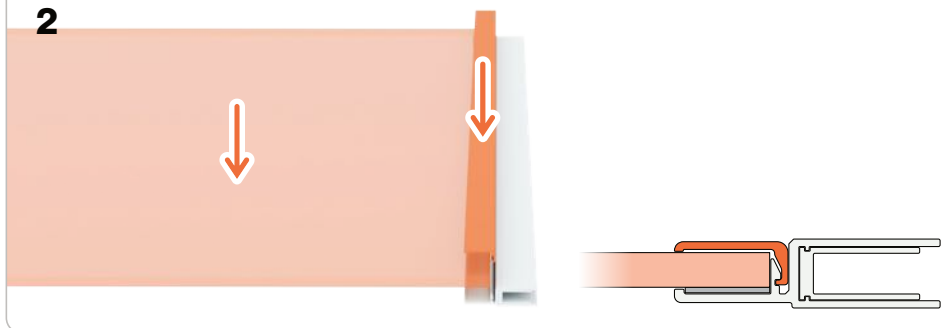

3

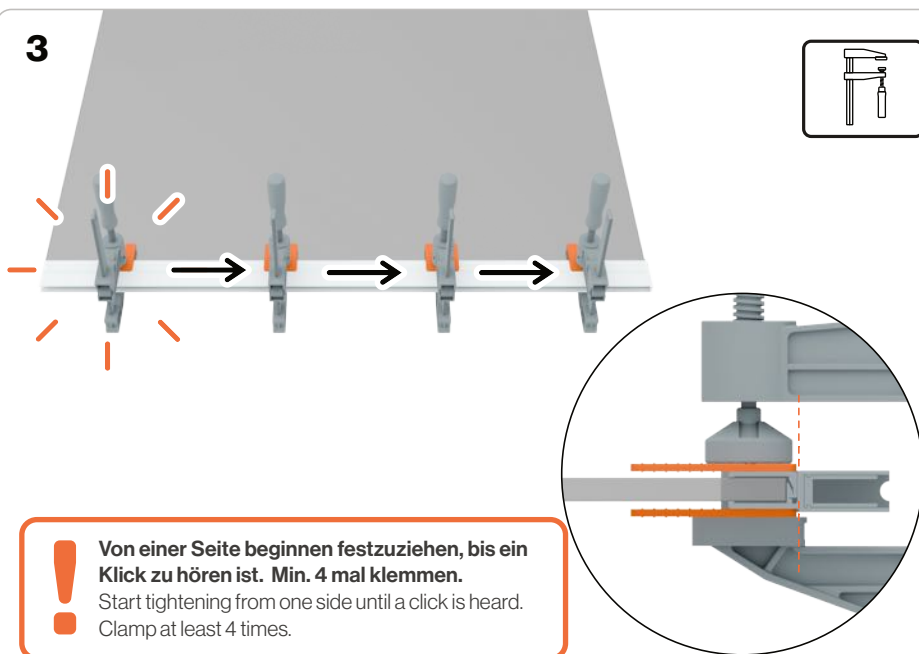

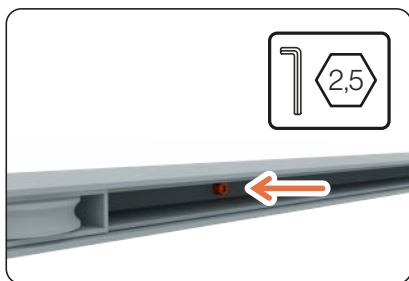
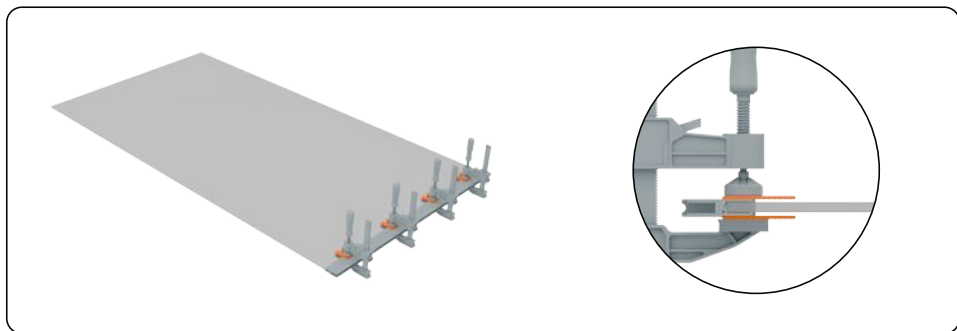
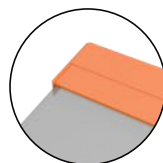
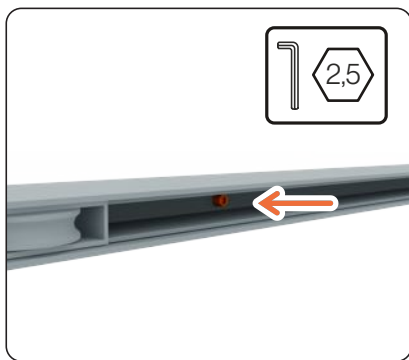

SCT09 - Montage Abdeckwinkel



Abdeckwinkel

1x

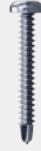

Linsenkopf-Bohrschraube

3,9x25

4x

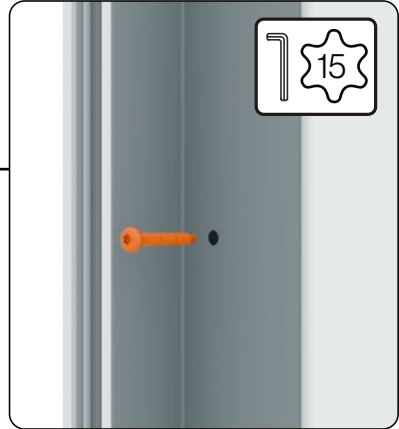

Schrauben nicht zu fest ziehen.

Do not tighten to much.

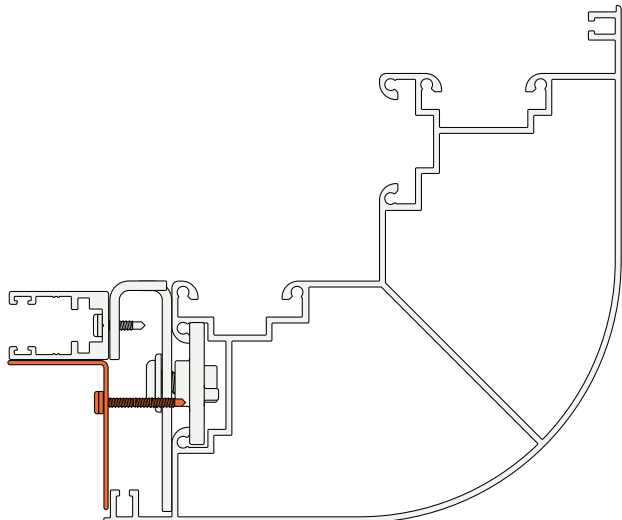

SCT10 - Schiebeelemente einhängen



Schiebetürelemente

3x

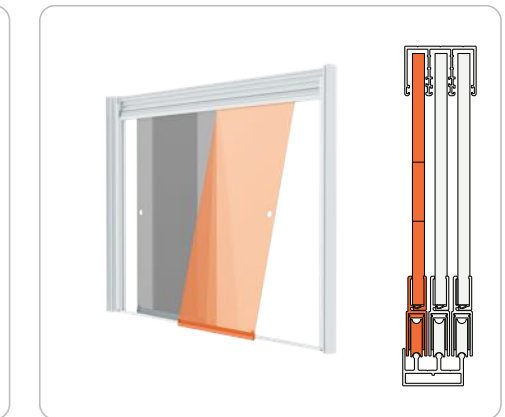
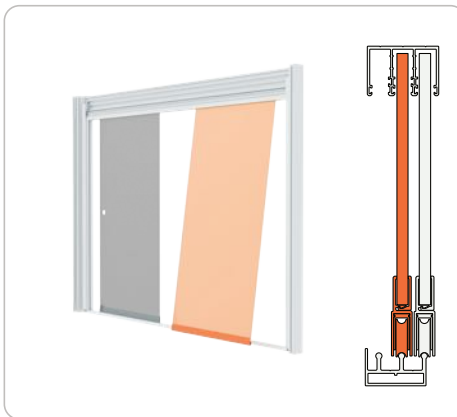
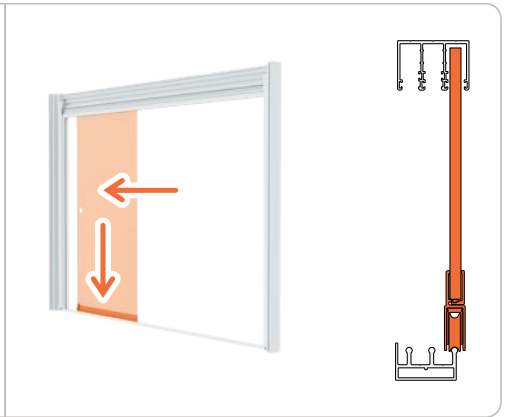
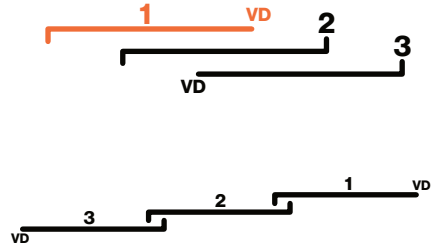
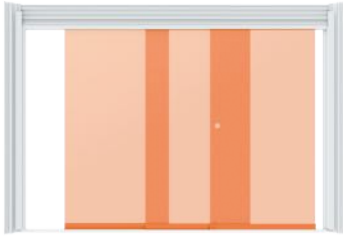

SCT11 - Einfassungen ausrichten

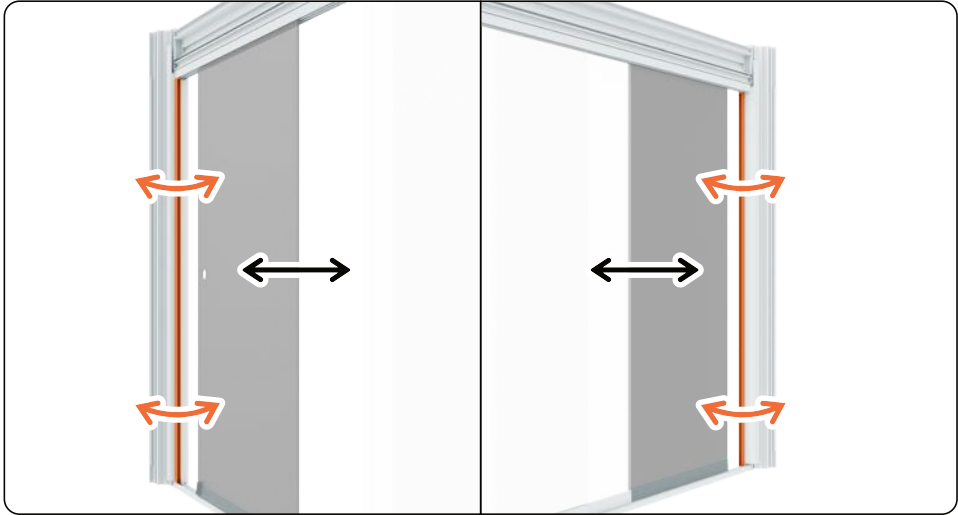

! Ecksteher/Seitenwände gemäß der Glaselemente ausrichten;
Glaseinfassungsleiste muss parallel zum Glas sein - Glas muss in die Glaseinfassungsleiste einfahren können.

Align corner posts/side walls according to the glass elements; the glazing bead must be parallel to the glass - the glass must be able to slide into the glazing bead.

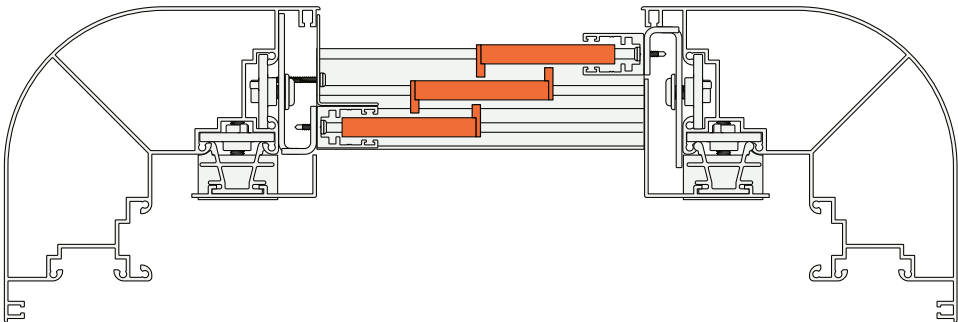

SCT12 - Vorbereitung Schiebeelemente



Laufschiene
mit Verriegelungsmechanik

1x



Verriegelungshebel

1x

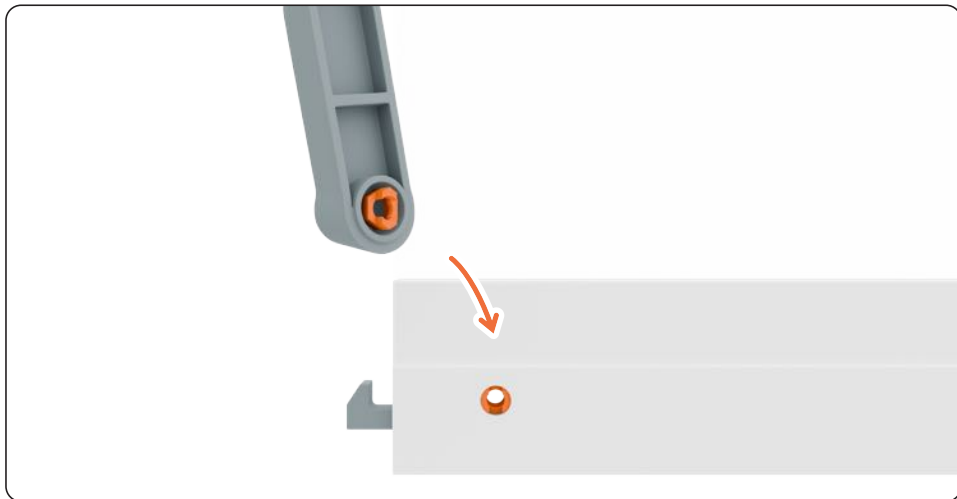

■ SCT13 - Verriegelung einstellen

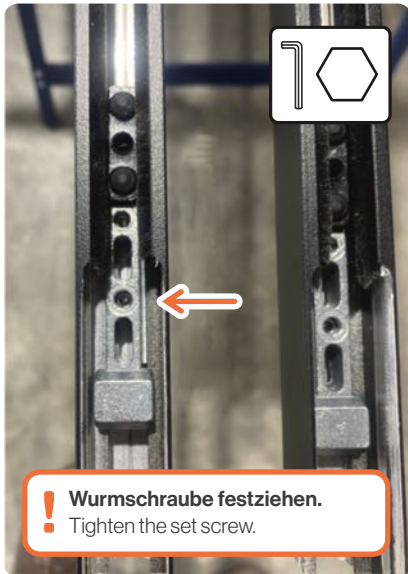
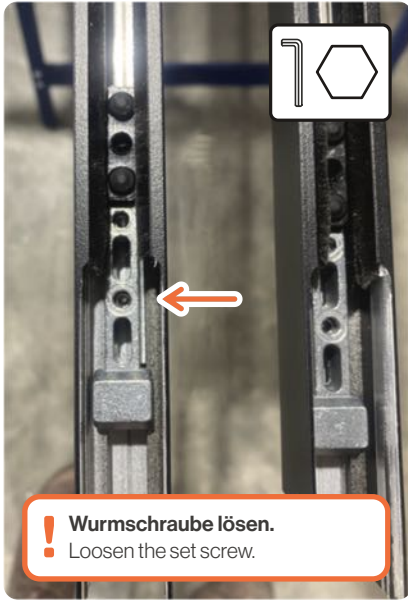

SCT14 - Bodenschiene befestigen

Schrauben je nach Untergrund

3x

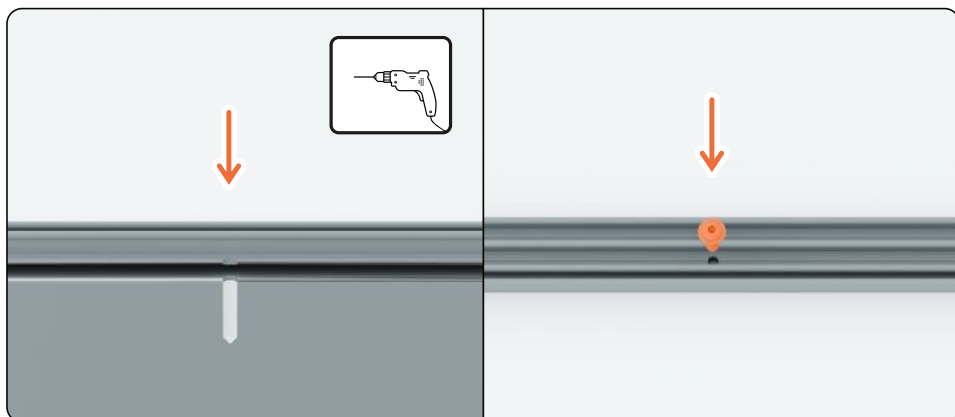

Entsprechend dem gewählten Fundament muss die Bodenschiene sicher verschraubt werden.



Depending on the selected foundation, the floor rail must be securely bolted.

SCT15 - Aushängesicherung einstellen

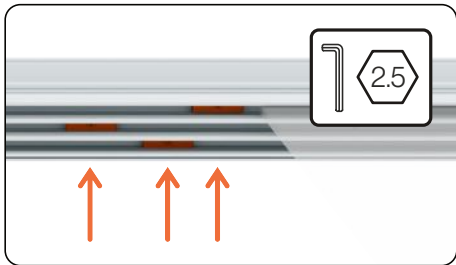
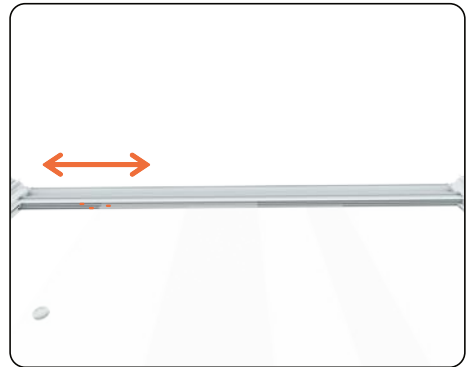
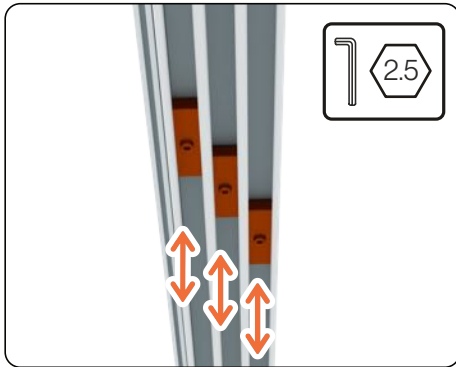

! Die Aushängesicherungen jeweils in die Mitte der Scheiben platzieren.
Place the safety retainers in the center of each glass panel.

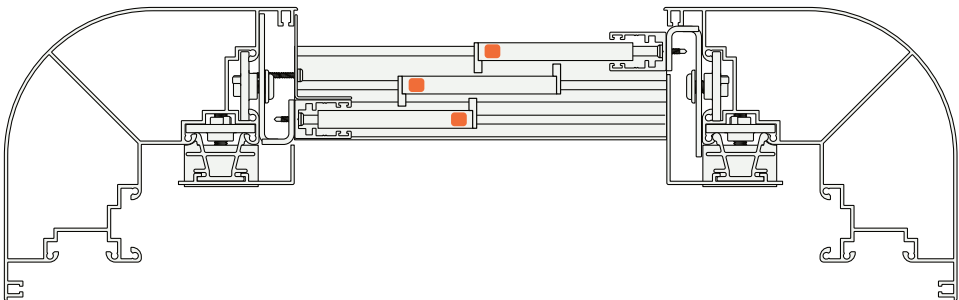

SCT16 - Griffmuscheln montieren



Griffmuschel

2x

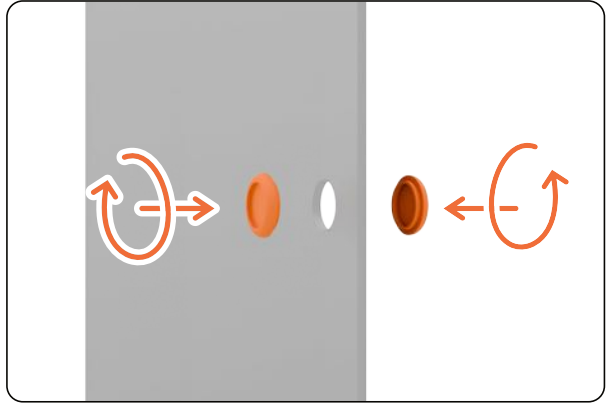

SCT17 - Bürstenleisten montieren

Bürstenleiste

2x

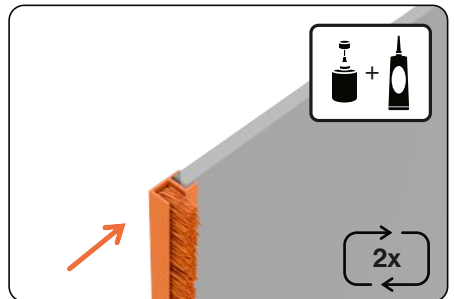

SCT18 - Montage Innenabdeckungsstopper



Innenabdeckungs-
stopper

2x



Nutstein

2x

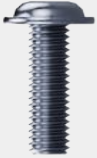

Schraube
M8x25

2x

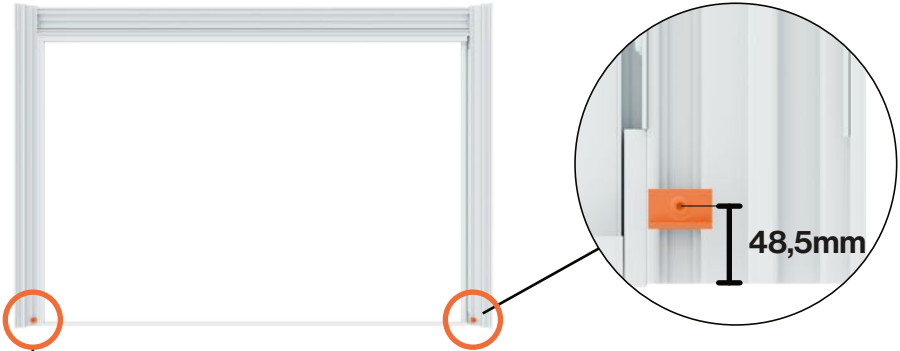

SCT19 - Montage Innenabdeckung

	Innenabdeckung L 1x		Innenabdeckung R 1x
	Abdeckklipp hoch 8x		

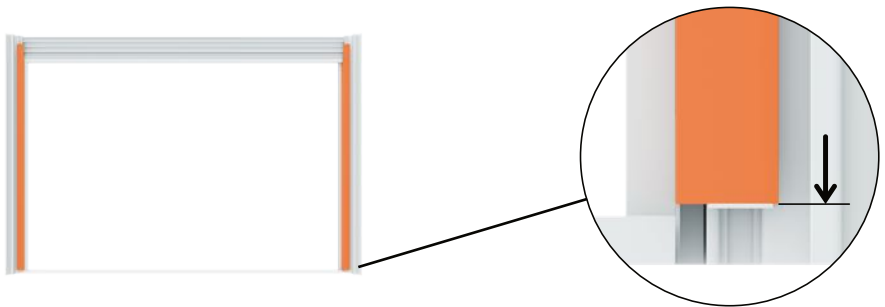

1

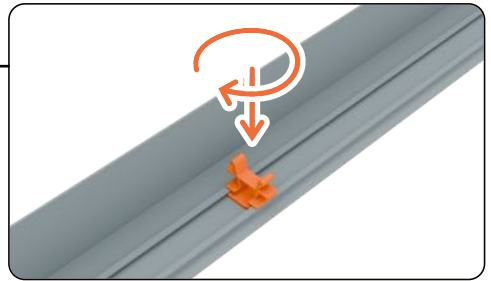
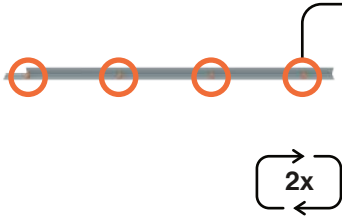



SUNELEMENTS GMBH

Sportstraße 7
4142 Hofkirchen i. M.
Austria

www.sunelements.at
office@sunelements.at

+43 7285 93 08 00