



**AUFBAUANLEITUNG  
SCHIEBETÜR 2M/3M**

# Schiebetür 2m/3m

sliding door 2m/3m



# SCT00 - System Übersicht

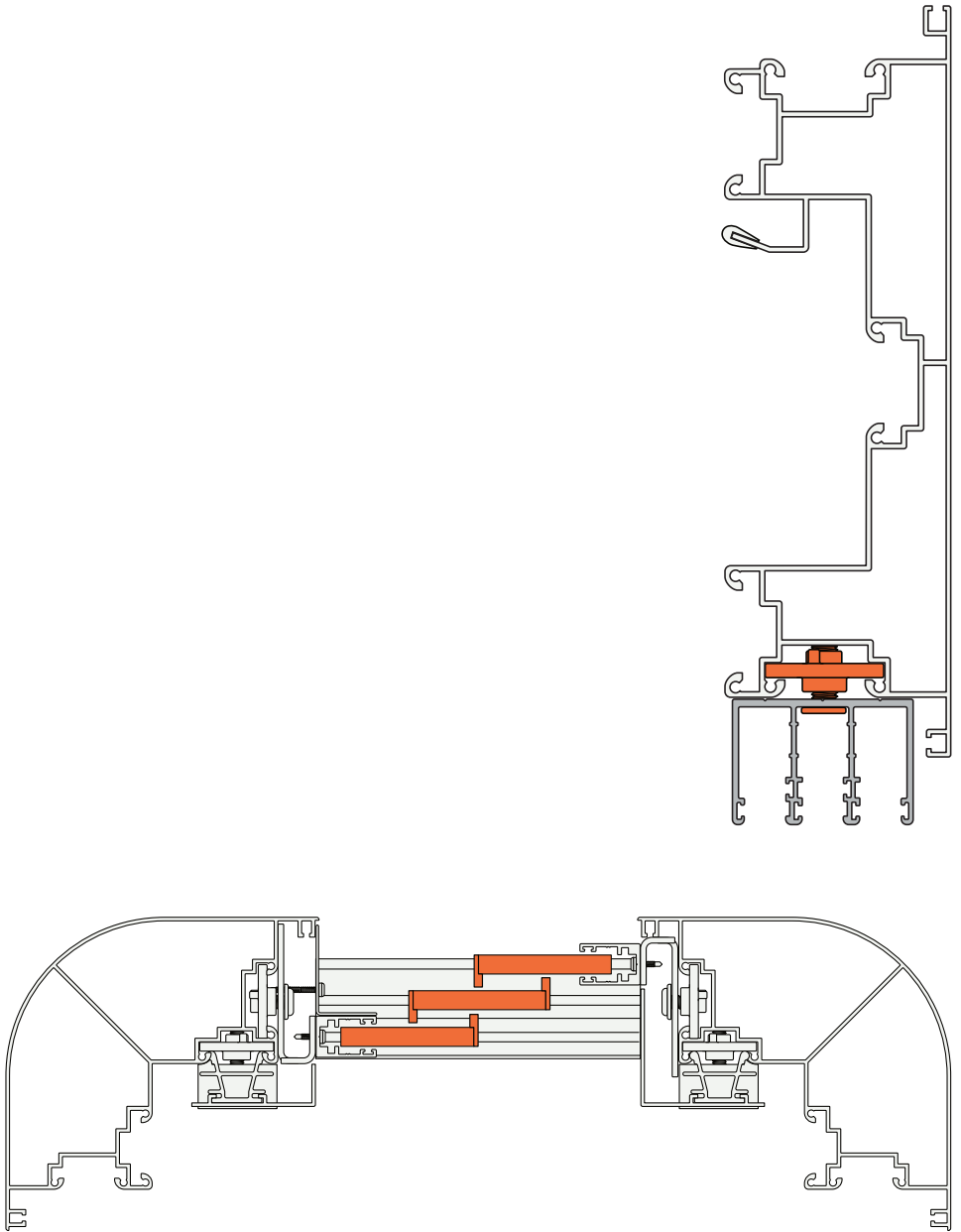

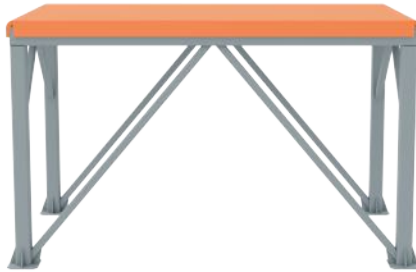

**Die Arbeitsfläche (Böcke, Werkbank...) für die Auflage der Glasscheiben polstern.**

**Kratzer am Glas müssen vermieden werden!**



Pad the work surface (trestles, workbench, etc.) where the glass panes are placed.

Scratches on the glass must be avoided!

## SCT02 - Montage Anschlagleisten



Anschlagleiste

2x



Nutstein

10x



Füllblock

2x



Breitflanschschraube  
**M8x16**

10x



**Ansicht von innen.**  
View from the inside.

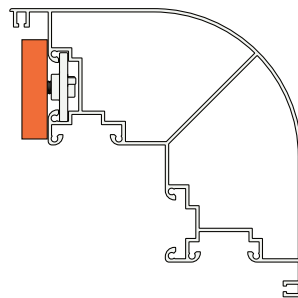
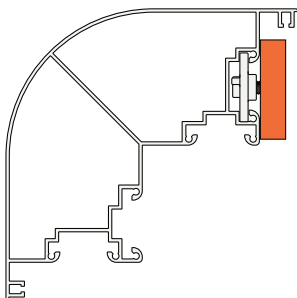

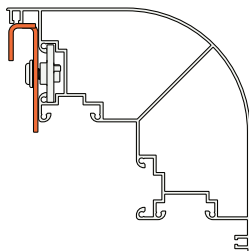
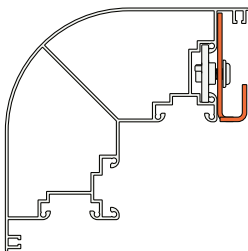
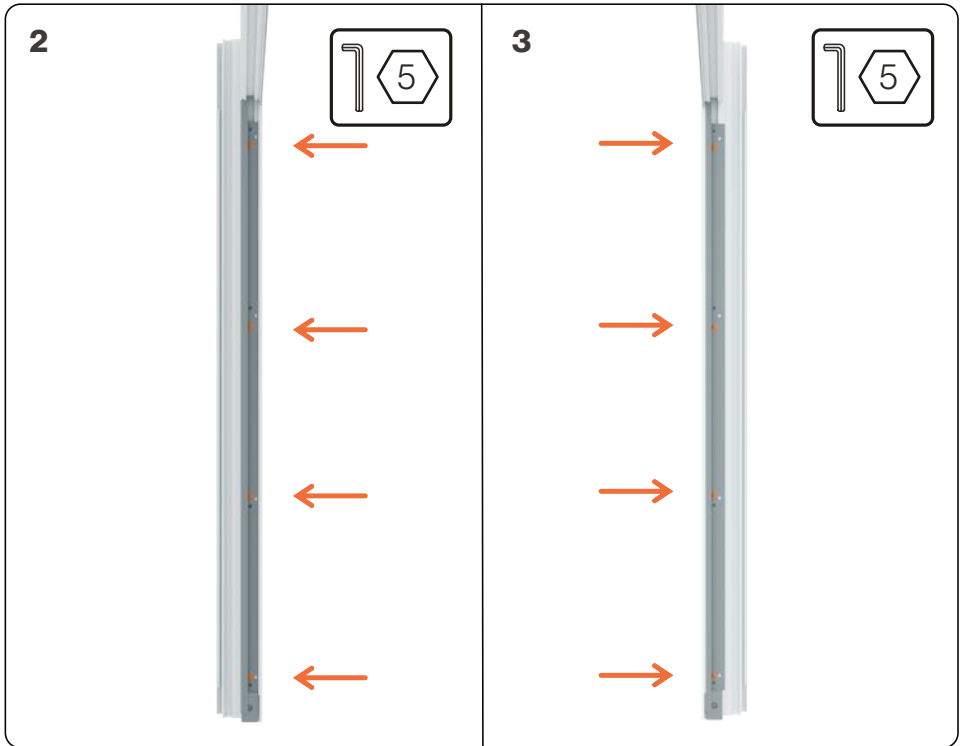
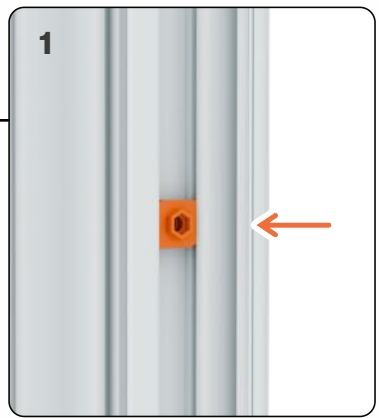

# SCT03 - Befestigungslöcher Deckenschiene bohren

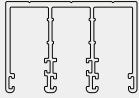

Deckenschiene  
3-gleisig

1x

150mm    ~700mm    ~700mm    ~700mm    ~700mm    150mm

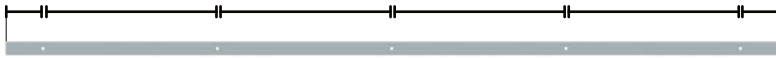

<p>1    2    3</p>	<p>Ø4</p>
<p>8,5-9</p>	<p>Alle Löcher entgraten. Deburr all holes.</p> <p>6x</p>

# SCT04 - Montage Deckenschiene



Nutstein

6x

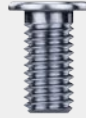

Schraube  
**M8x16**

6x

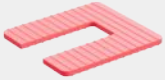

Distanzplättchen

3x

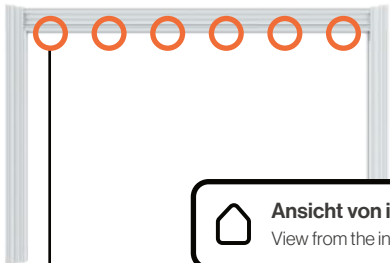

Ansicht von innen.  
View from the inside.

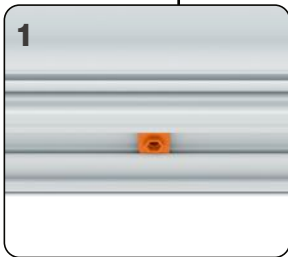

1

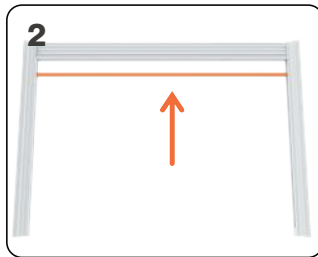

2

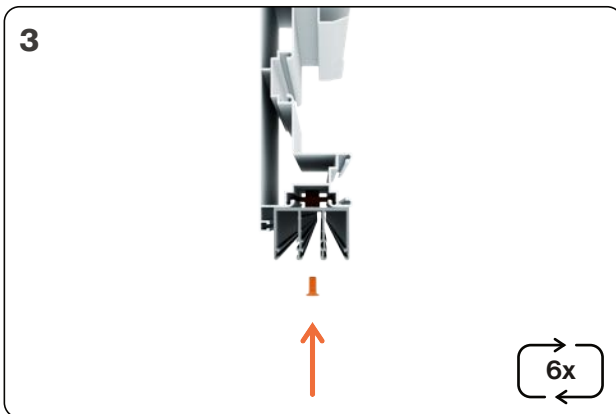

3

6x

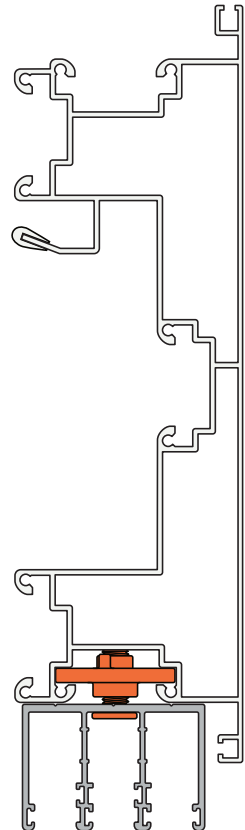

1

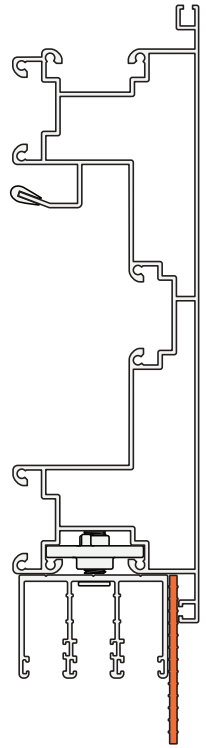
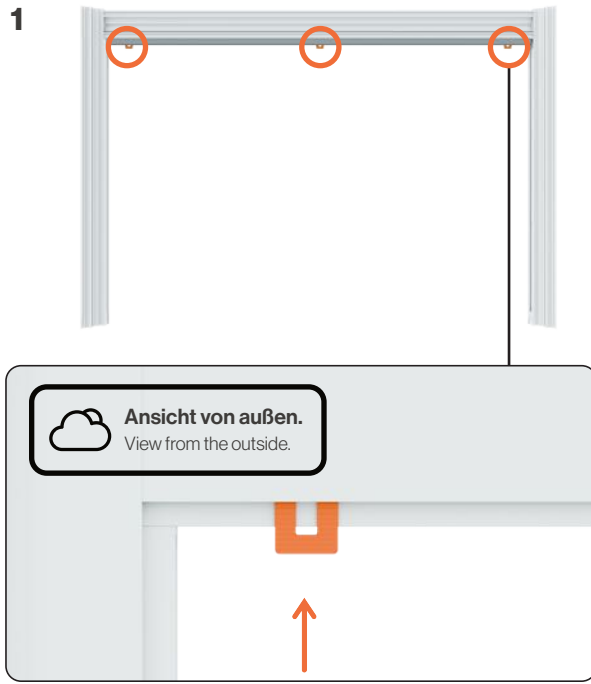

2

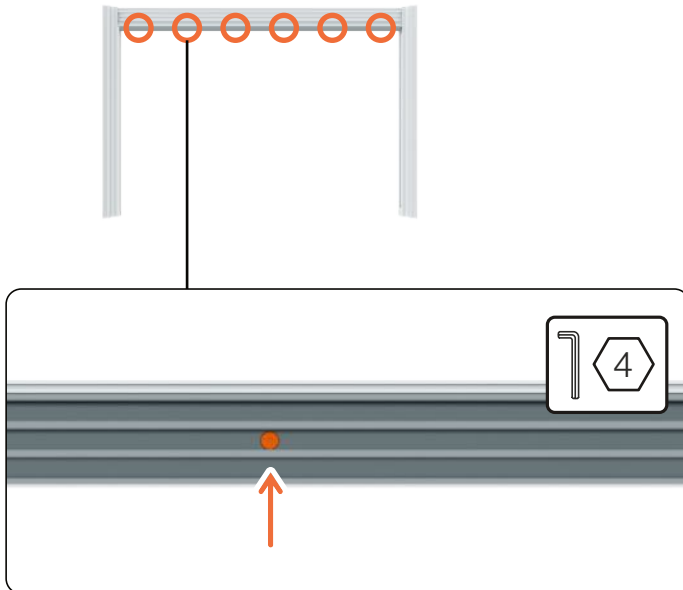

# SCT05 - Vorbereitung Bodenprofil

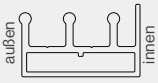

Bodenprofil

1x



Abdeckung  
Bodenschiene

1xL 1xR

100mm -700mm -700mm -700mm -700mm 100mm

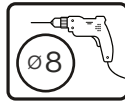

Je nach  
Schraube

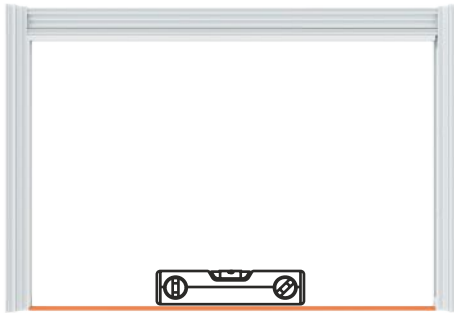
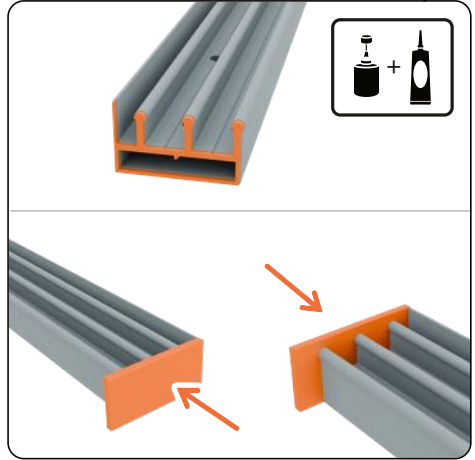

**Bodenschiene noch nicht festschrauben.**

**Die Löcher im Untergrund erst nach Fertigstellung der gesamten Anlage bohren.**

Do not screw down the bottom track yet.



Drill the holes in the ground only after the entire structure is completed.

# SCT06 - Vorbereitung Glaseinfassungsprofil

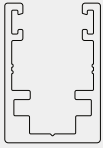

Glaseinfassungsprofil

1x

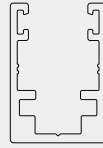

Glaseinfassungsprofil  
MIT FRÄSUNG

1x

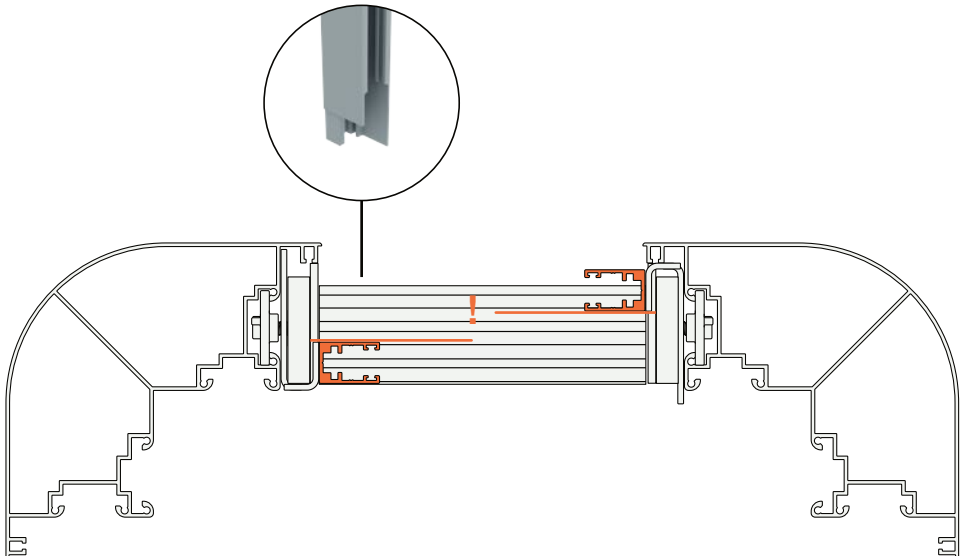
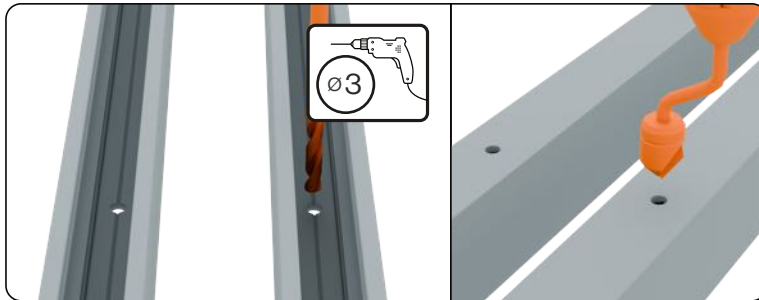
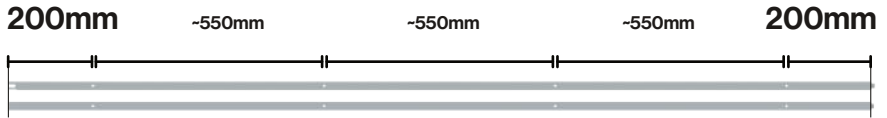

1



 **Ansicht von innen.**  
View from the inside.

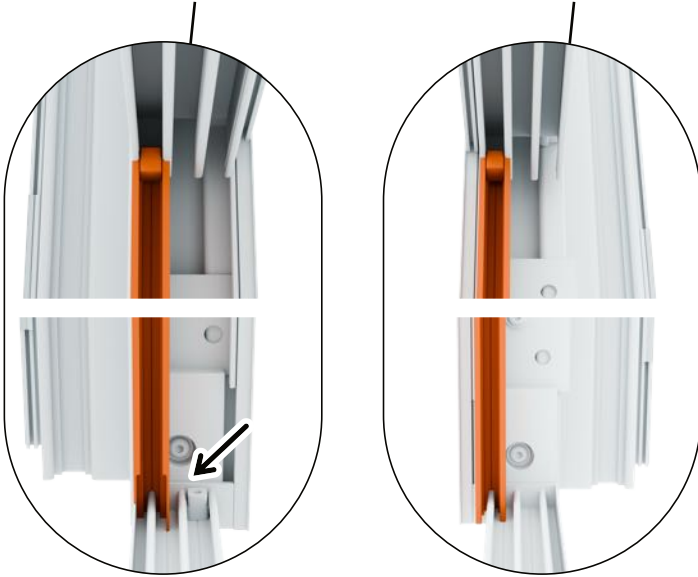

2

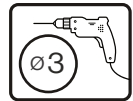
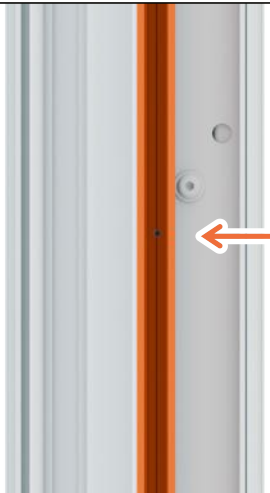

## SCT07 - Montage Glaseinfassungsprofil



Schraube

**3,9x13**

8x

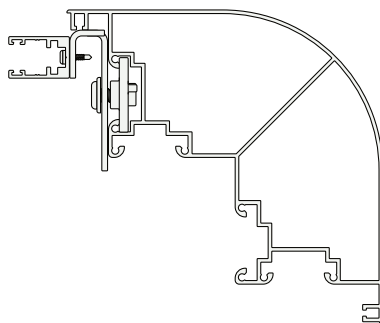
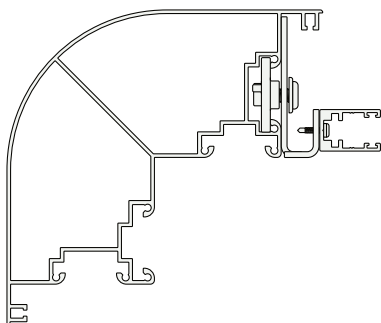
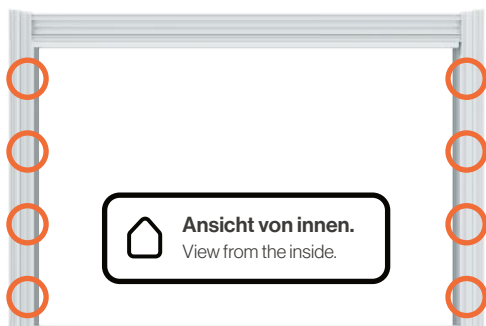

## SCT08 - Glas vorbereiten

	<p><b>Laufschiene mit/ohne Verriegelungsmechanik</b></p> <p><b>2x/1x</b></p>		<p><b>Fixierungsleiste</b></p>
	<p><b>Distanzplättchen 3mm wiederverwenden</b></p> <p><b>8x</b></p>		<p><b>Wurmschraube M5x5</b></p> <p><b>6x</b></p>

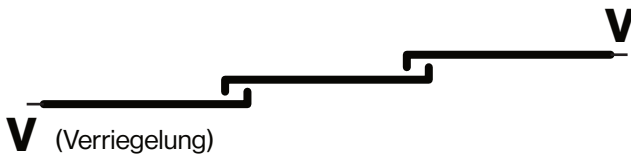
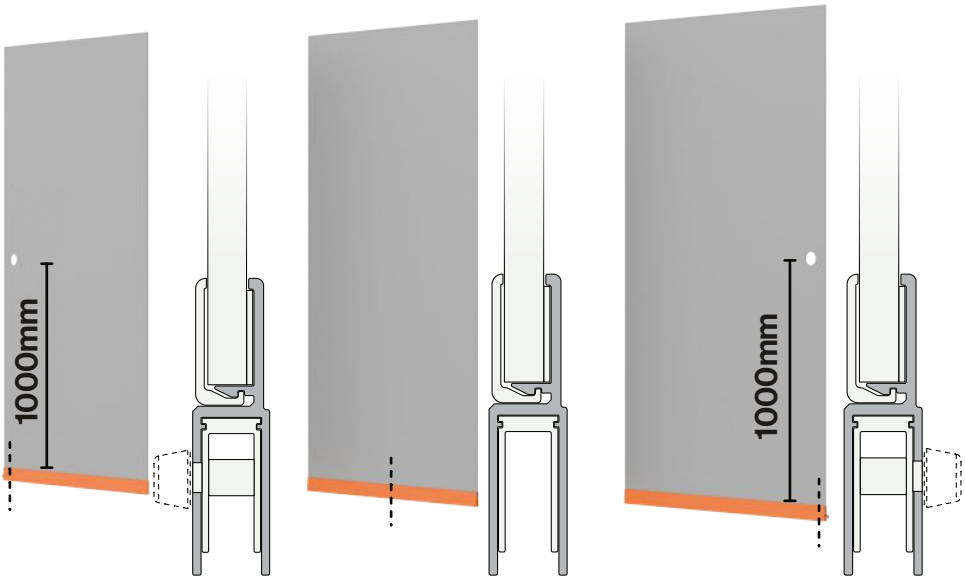

**!** **Grifflöcher ganz links und ganz rechts, Fixierungsleiste immer innen oder außen, Verriegelung links außen und rechts innen.**

**■** Grip holes on the far left and far right, fixing strip always on the inside or outside, locking mechanism on the left outside and right inside.



**Außenseite nach unten (Sticker am Glas).  
Klebbereich reinigen und abtrocknen lassen.**

- ! Outside facing down (sticker on glass).
- Clean the bonding area and let it dry.

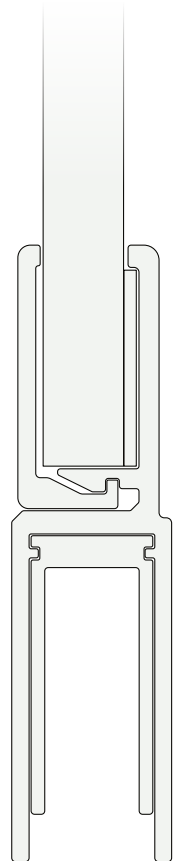
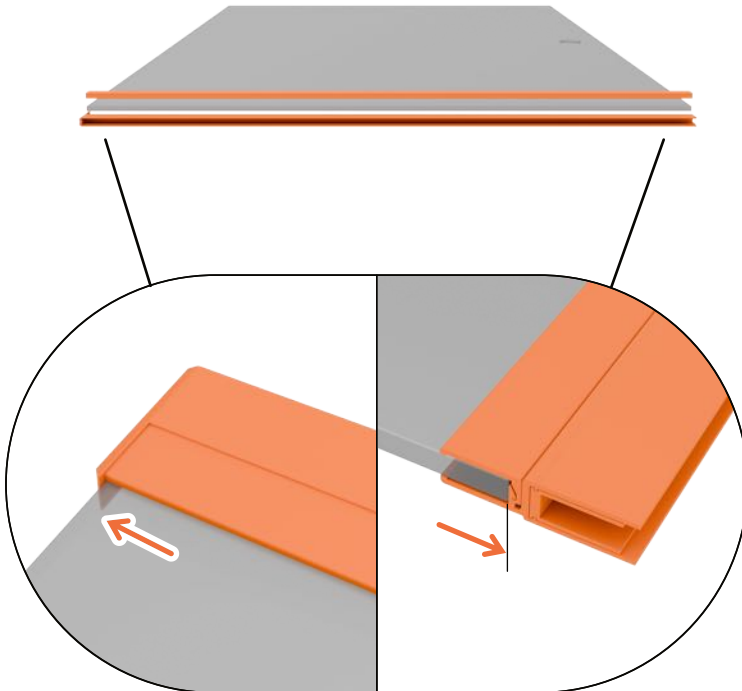
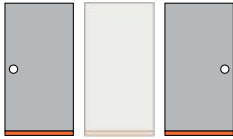

1



2

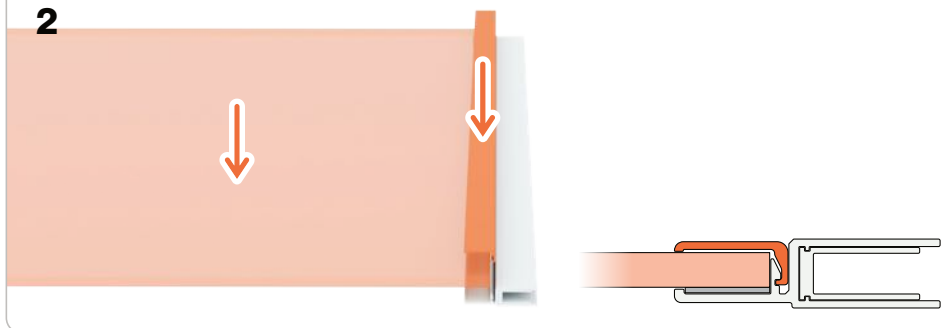

3

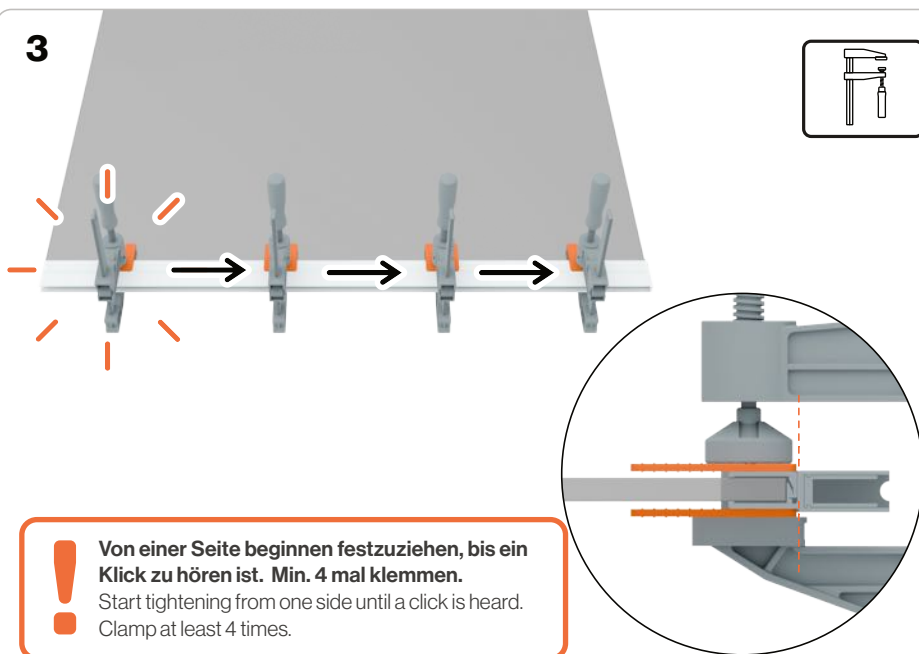

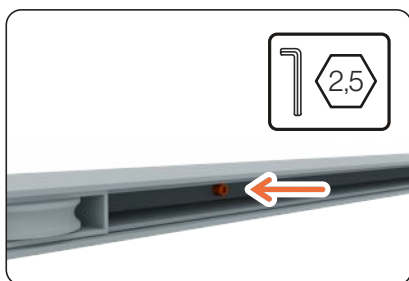
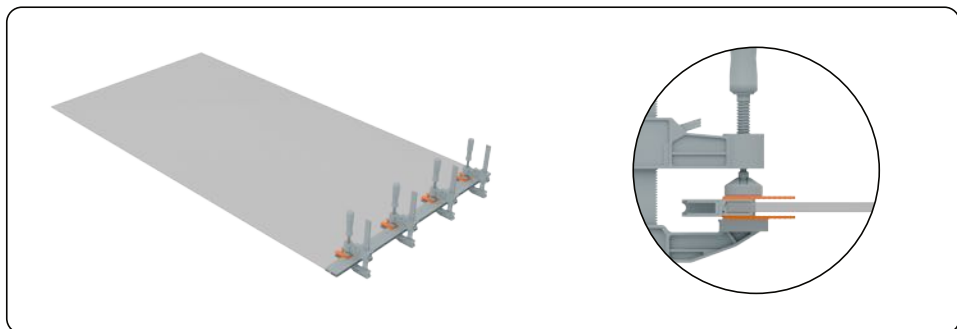
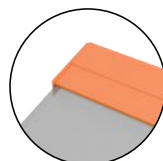
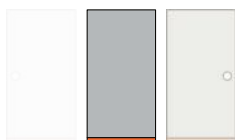
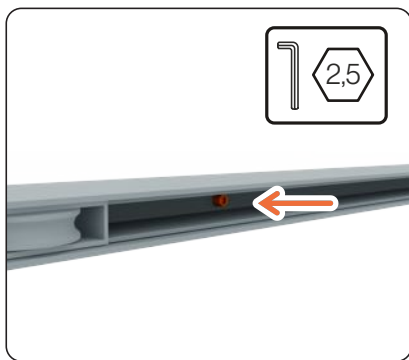

## SCT09 - Montage Abdeckwinkel



Abdeckwinkel

1x

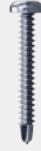

Linsenkopf-Bohrschraube

3,9x25

4x

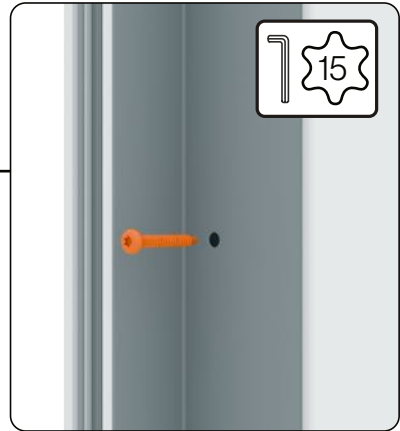

**Schrauben nicht zu fest ziehen.**

Do not tighten to much.

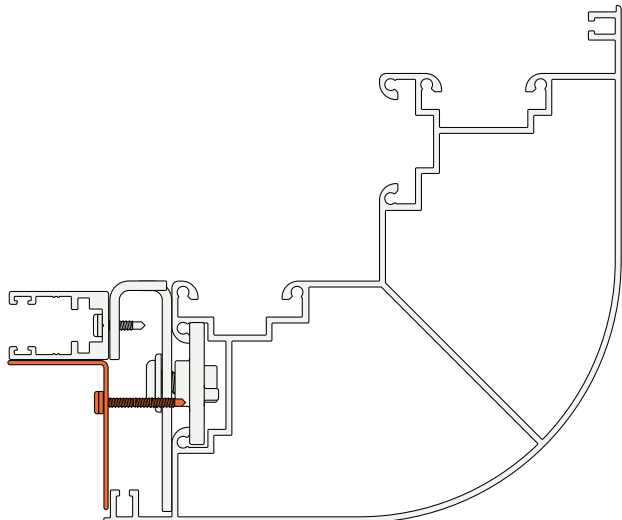

# SCT10 - Schiebeelemente einhängen



Schiebetürelemente

3x

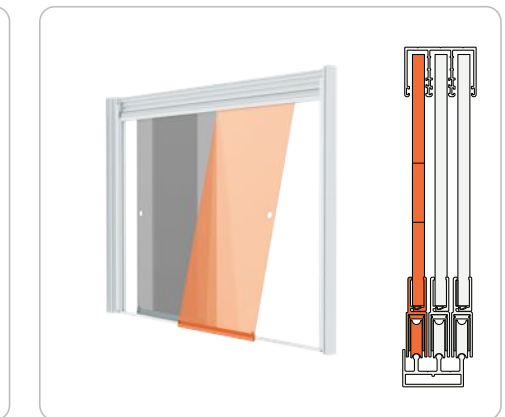
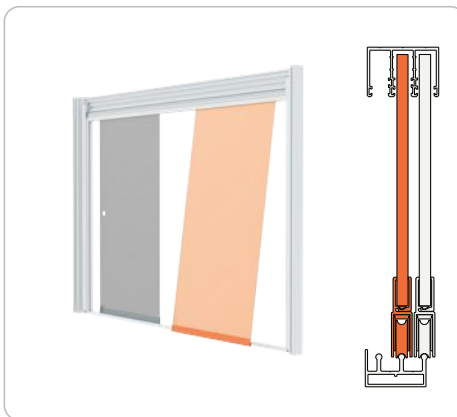
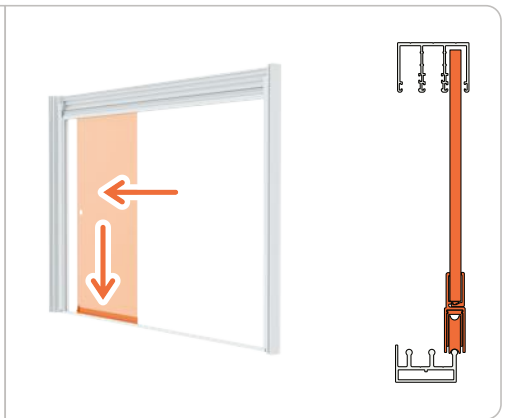
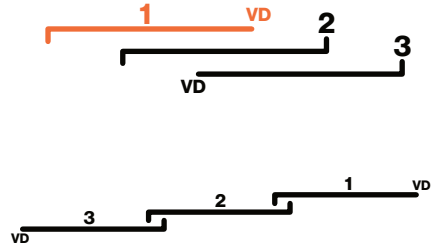
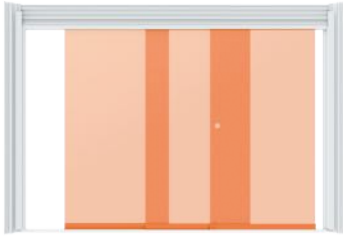

## SCT11 - Einfassungen ausrichten

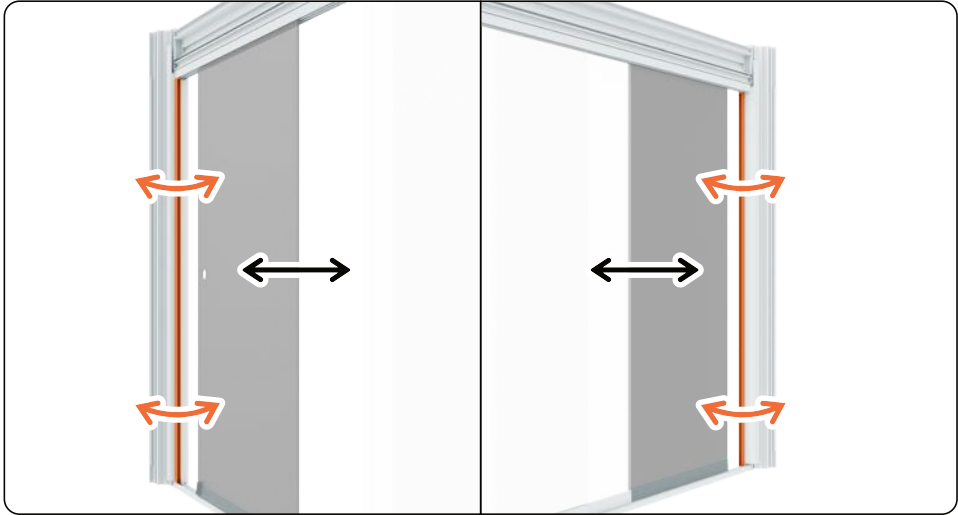

**!** Ecksteher/Seitenwände gemäß der Glaselemente ausrichten;  
Glaseinfassungsleiste muss parallel zum Glas sein - Glas muss in die Glaseinfassungsleiste einfahren können.

Align corner posts/side walls according to the glass elements; the glazing bead must be parallel to the glass - the glass must be able to slide into the glazing bead.

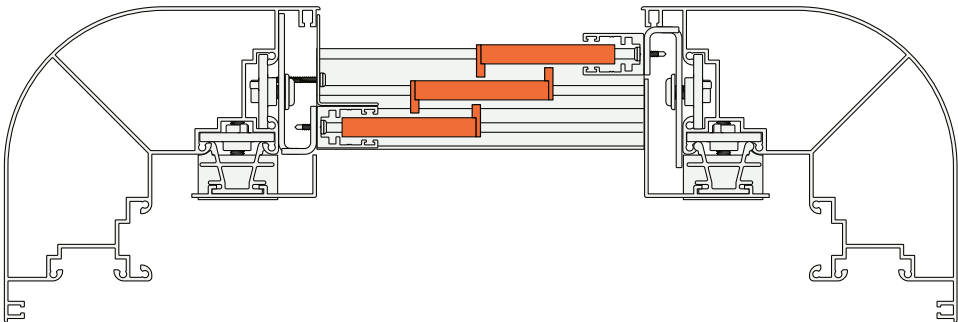

## SCT12 - Vorbereitung Schiebeelemente



Laufschiene  
mit Verriegelungsmechanik

1x



Verriegelungshebel

1x

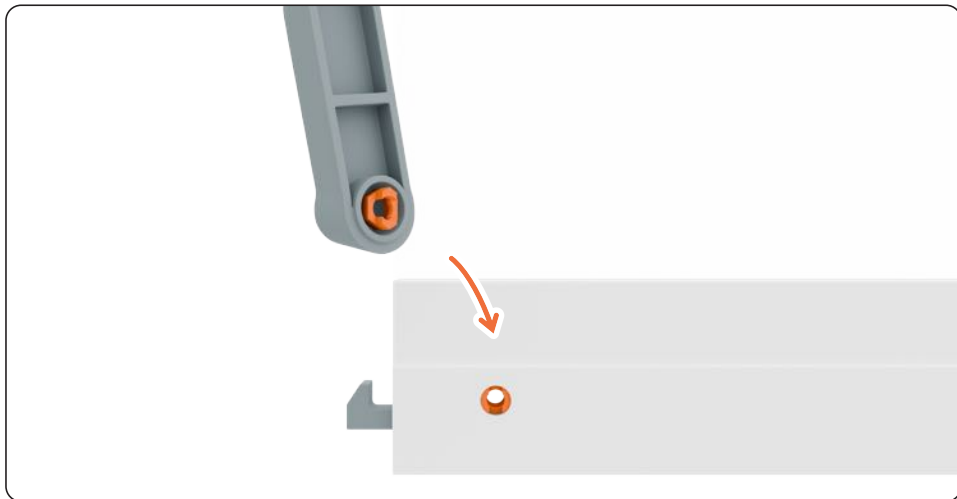

## ■ SCT13 - Verriegelung einstellen

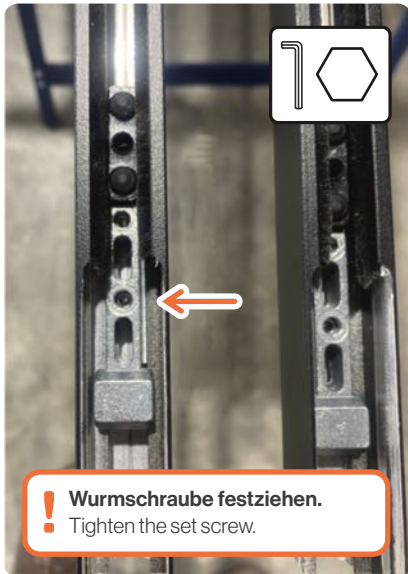
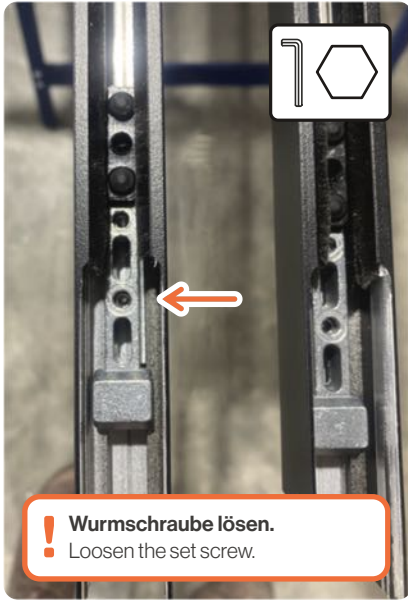

## SCT14 - Bodenschiene befestigen

Schrauben je nach Untergrund

3x

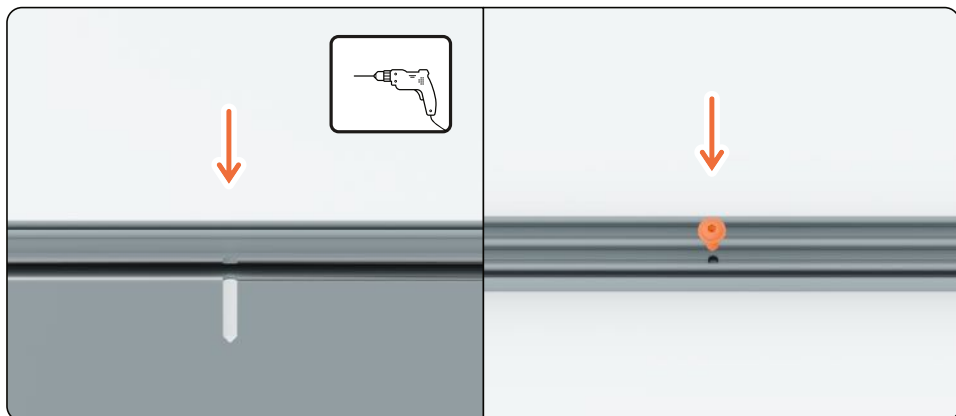

**Entsprechend dem gewählten Fundament muss die Bodenschiene sicher verschraubt werden.**



Depending on the selected foundation, the floor rail must be securely bolted.

## SCT15 - Aushängesicherung einstellen

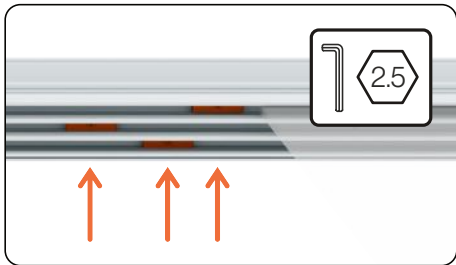
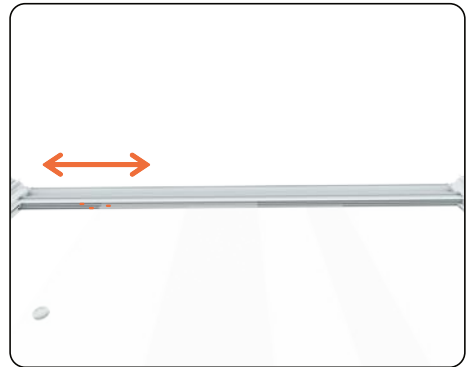
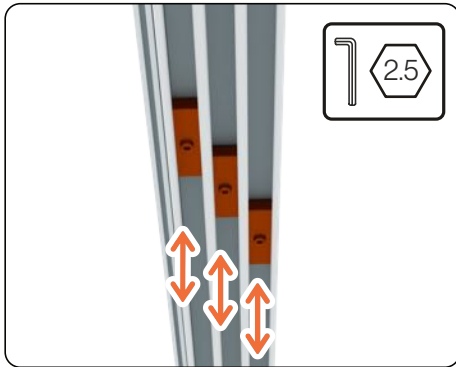

**!** Die Aushängesicherungen jeweils in die Mitte der Scheiben platzieren.  
Place the safety retainers in the center of each glass panel.

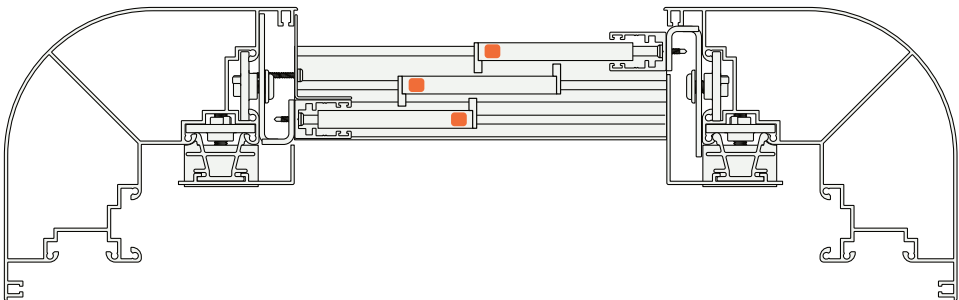

## SCT16 - Griffmuscheln montieren



Griffmuschel

2x

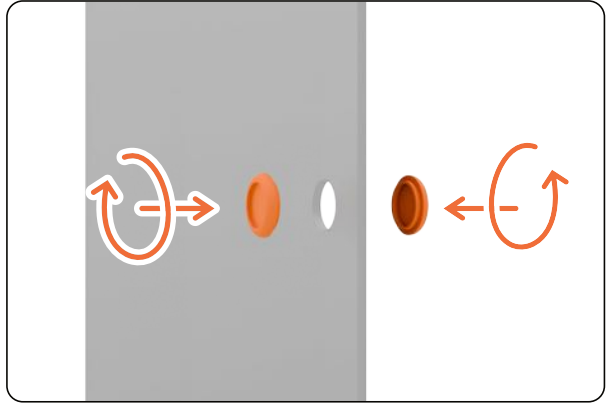

## SCT17 - Bürstenleisten montieren

Bürstenleiste

2x

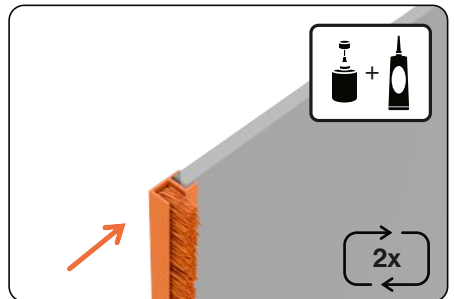

## SCT18 - Montage Innenabdeckungsstopper



Innenabdeckungs-  
stopper

2x



Nutstein

2x

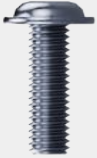

Schraube  
**M8x25**

2x

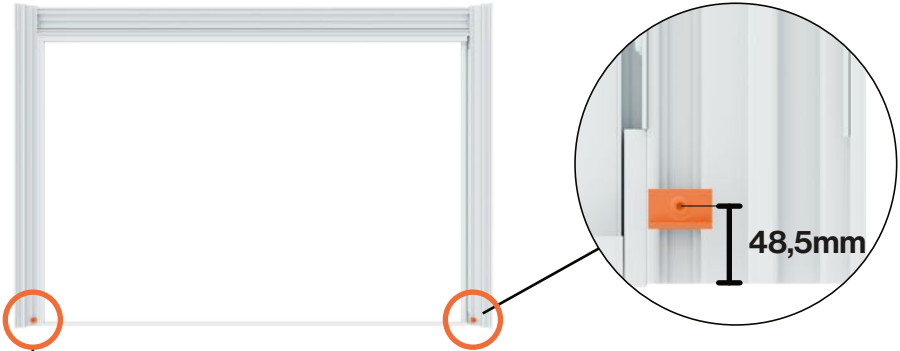

# SCT19 - Montage Innenabdeckung

	Innenabdeckung L  1x		Innenabdeckung R  1x
	Abdeckklipp hoch  8x		

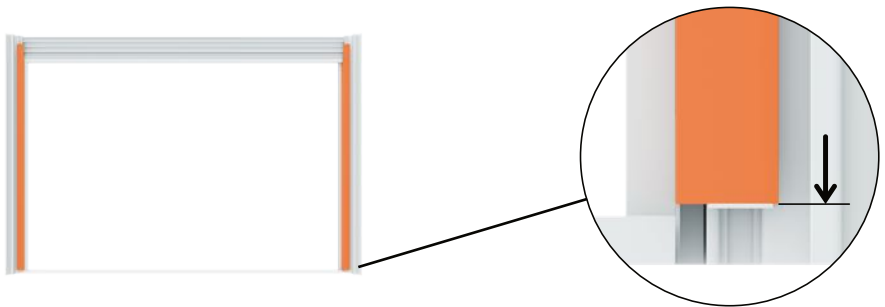

1

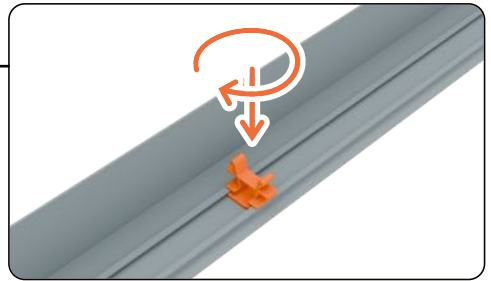
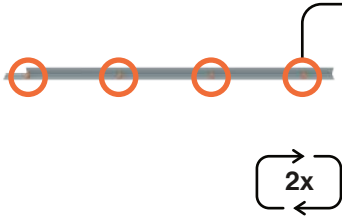



**SUNELEMENTS GMBH**

Sportstraße 7  
4142 Hofkirchen i. M.  
Austria

[www.sunelements.at](http://www.sunelements.at)  
[office@sunelements.at](mailto:office@sunelements.at)

+43 7285 93 08 00